

Designing Interactive Systems I

Interaction Design Notations

Prof. Dr. Jan Borchers
Media Computing Group
RWTH Aachen University

Winter Semester '23/'24

<https://hci.rwth-aachen.de/dis>



RWTHAACHEN
UNIVERSITY

Review

- Ten Golden Rules of Interface Design
- Human Deadlines
- Latency & Responsiveness



Interaction Design Notations

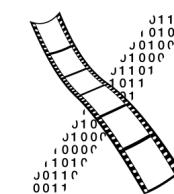

Interaction Design Notations

- Alan Dix et al.: [Human-Computer Interaction](#), 3rd ed. (2003), Chapter 16

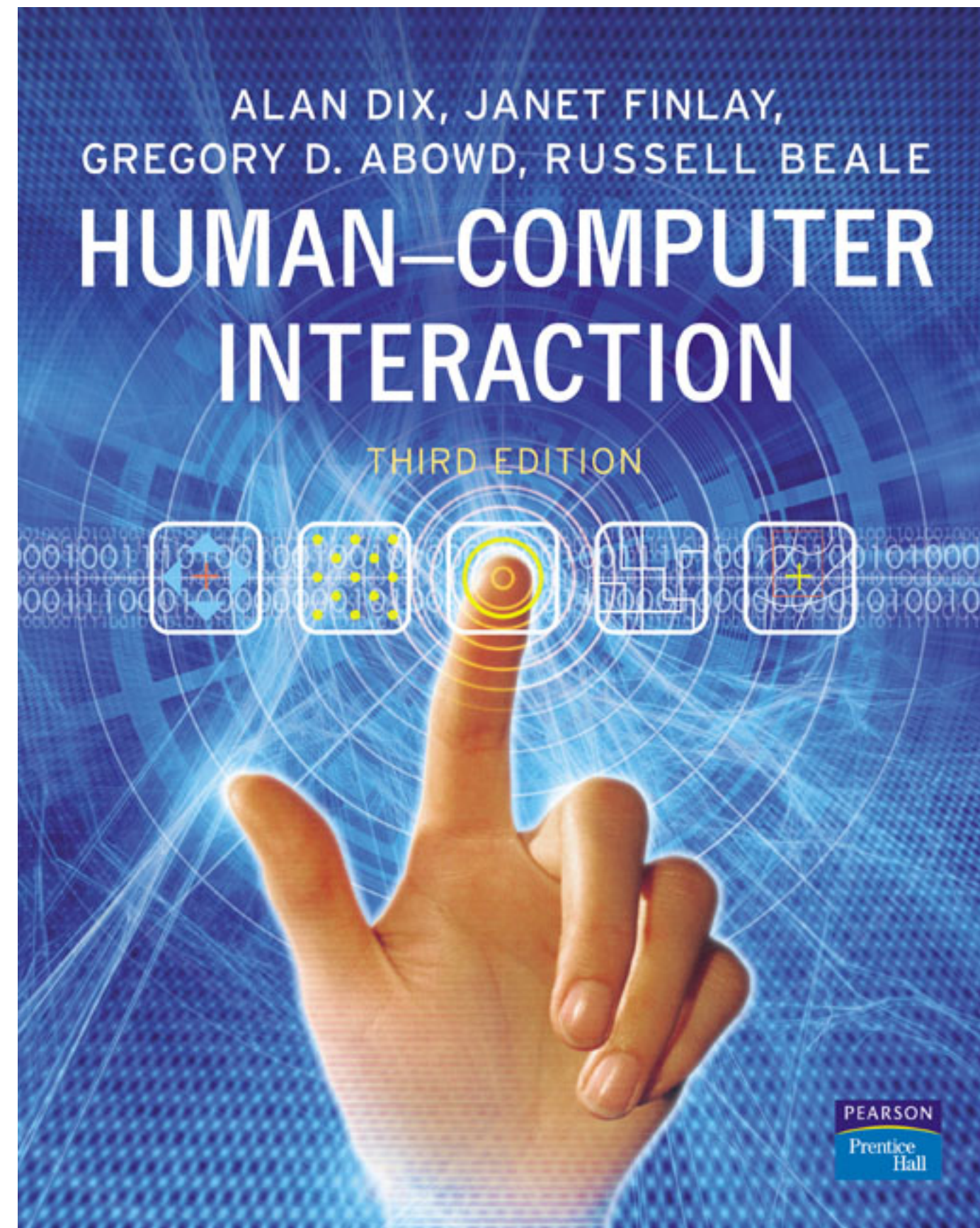

Back to BASICS

```
Print "Please enter a number"  
INPUT n  
Print "The square of",n,"is",n*n
```

- What are the problems with using such a notation to specify a dialog?

Why UI Specification Languages

- In normal programming languages, UI and algorithms are mixed up
- System and user decisions are hard to distinguish
- Error checking on inputs dominates and complicates code
- First step: bundling I/O in classes/procedures
- Second step: Use a more efficient, readable language to specify the dialog
 - A priori to design the dialog
 - As part of the implementation (executable spec.)



Specifying User Interfaces

- Problem: Describe the proposed design of a user interface
- Approach: natural/semi-formal/formal languages
- Many standard computer science techniques apply
- The more modern the UI, the harder to describe textually, depending on modality and UI style



Grammars

- Mostly BNF-like

```
expr ::= empty | atom expr | '(' expr ')' expr
```

- E.g., Shneiderman's multiparty grammar

```
<Session>      ::= <U: Opening> <C: Responding>  
<U: Opening>   ::= LOGIN <U: Name>  
<U: Name>      ::= <U: string>  
<C: Responding> ::= HELLO [<U: Name>]
```

- Great for command-line UIs, e.g., banking ATMs, Unix commands
- Less suitable for GUIs



Grammars

- Regular expressions
 - `select-line click click* double-click`

- E.g., Unix “copy” command synopsis:

```
cp [-R [-H | -L | -P]] [-f | -i | -n] [-pv] source_file target_file
cp [-R [-H | -L | -P]] [-f | -i | -n] [-pv] source_file ... target_dir
```

recursion policies

overwrite policies

- Short and precise, but hard to read, requires additional information about semantics

Production Rules

- Unordered list of rules: `if condition then action`
 - Condition based on state or pending events
 - Every rule always potentially active
- Good for concurrency
- Bad for sequence



Event-based Production Rules

```
select-line → first  
click first → rest  
click rest → rest  
double-click rest → <draw line>
```

- Note:
 - Events added to list of pending events
 - ‘first’ and ‘rest’ are internally generated events
- Bad at state!



Graph Notations: STNs

- State Transition Networks (STNs)
 - Most common tool to specify dialogs
 - Established format (since 1960s)
- Consisting of:
 - **States** (usually the system waiting for some user action)
 - **Transitions** (which have a **user action** and a **system response** associated with them)
- Describes **sequences** of user actions and system responses



Graph Notations: STNs

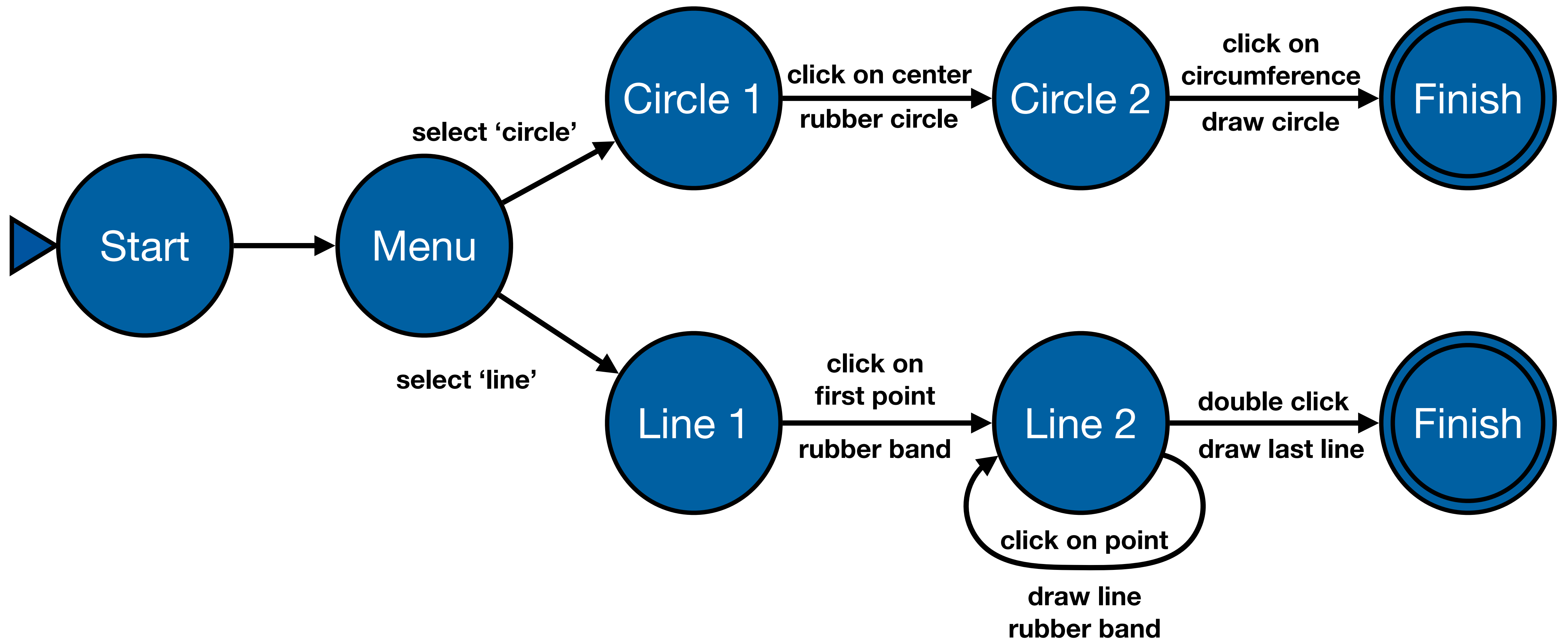



Example: STN for Personal Orchestra Dialog

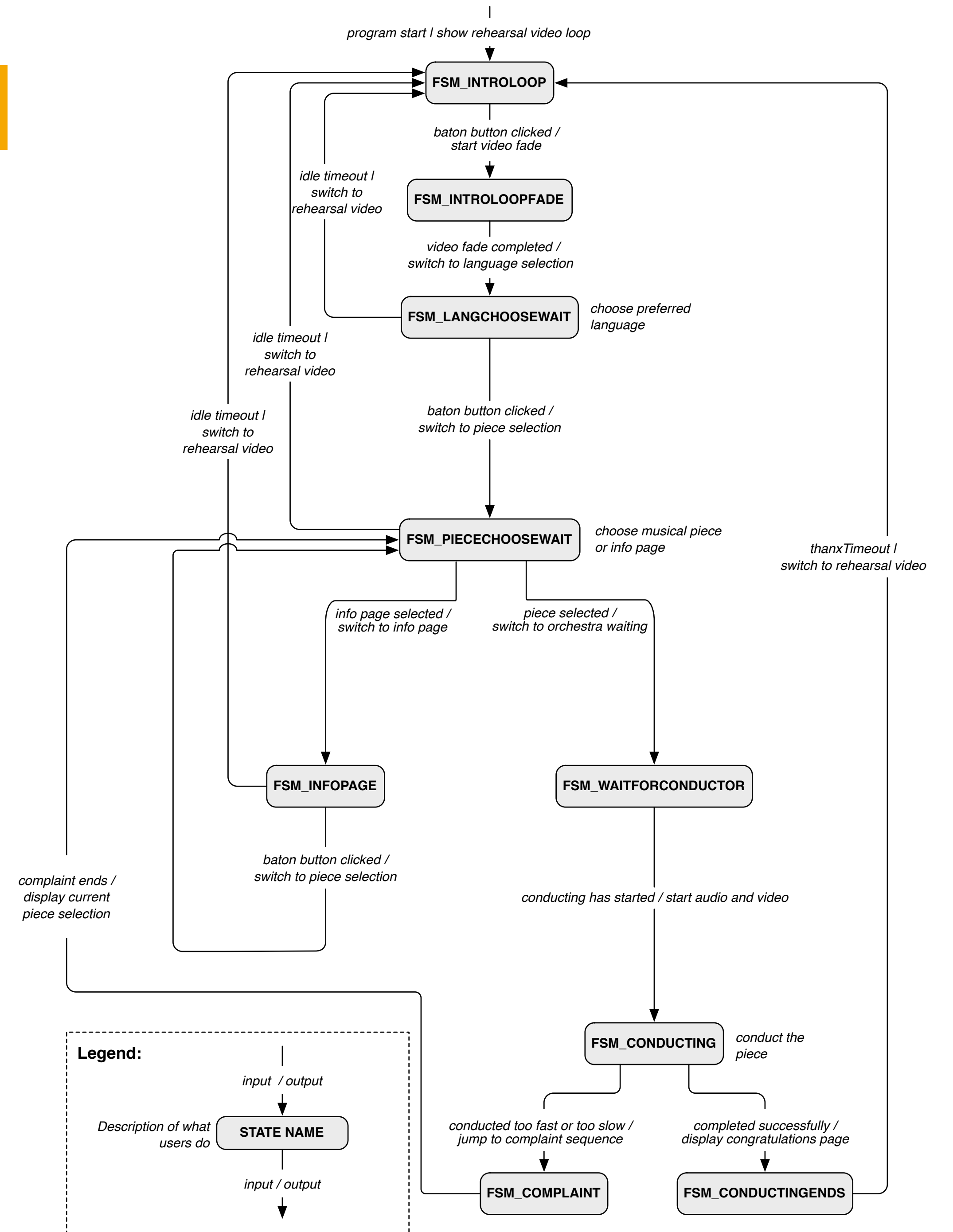

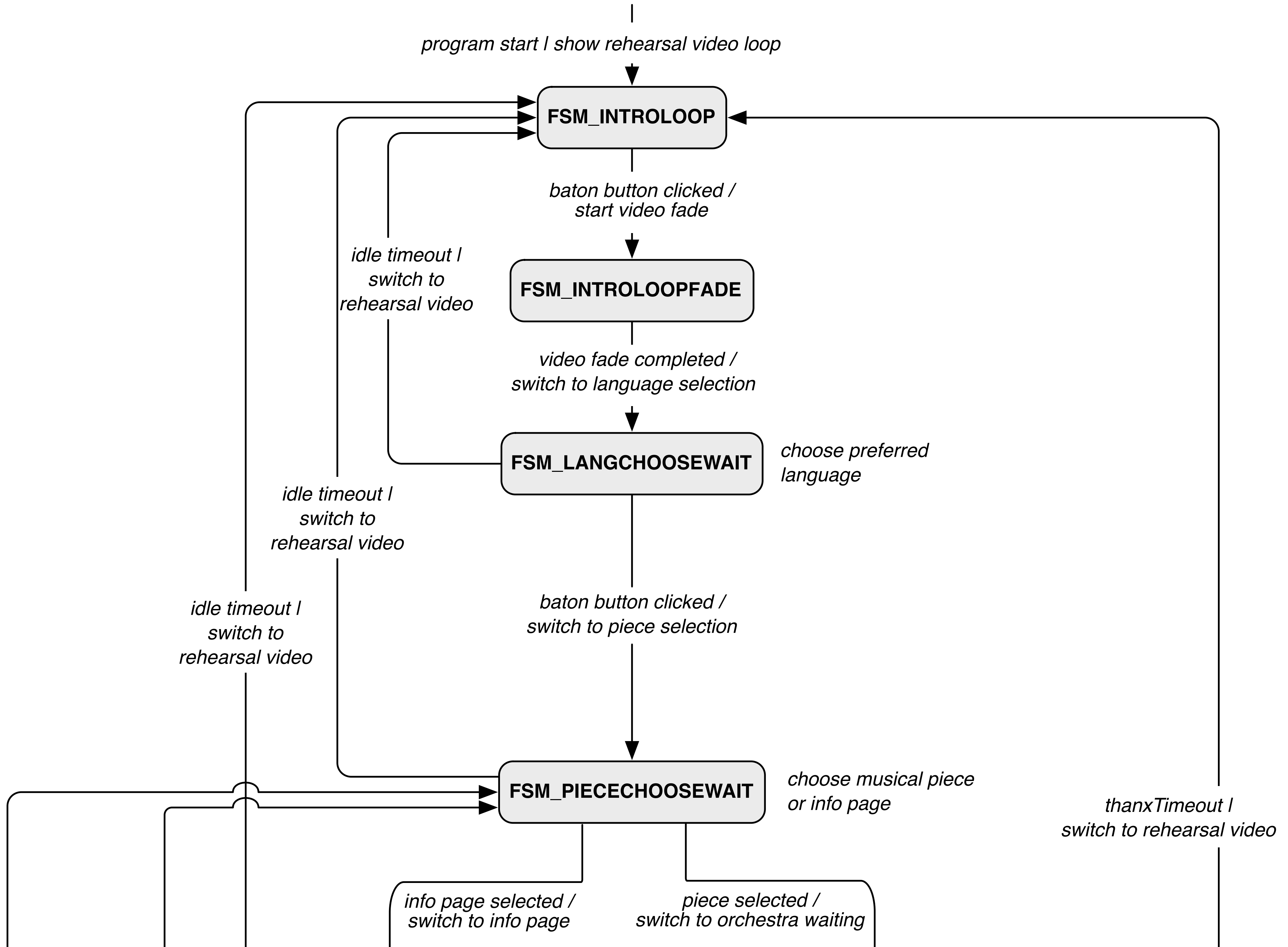

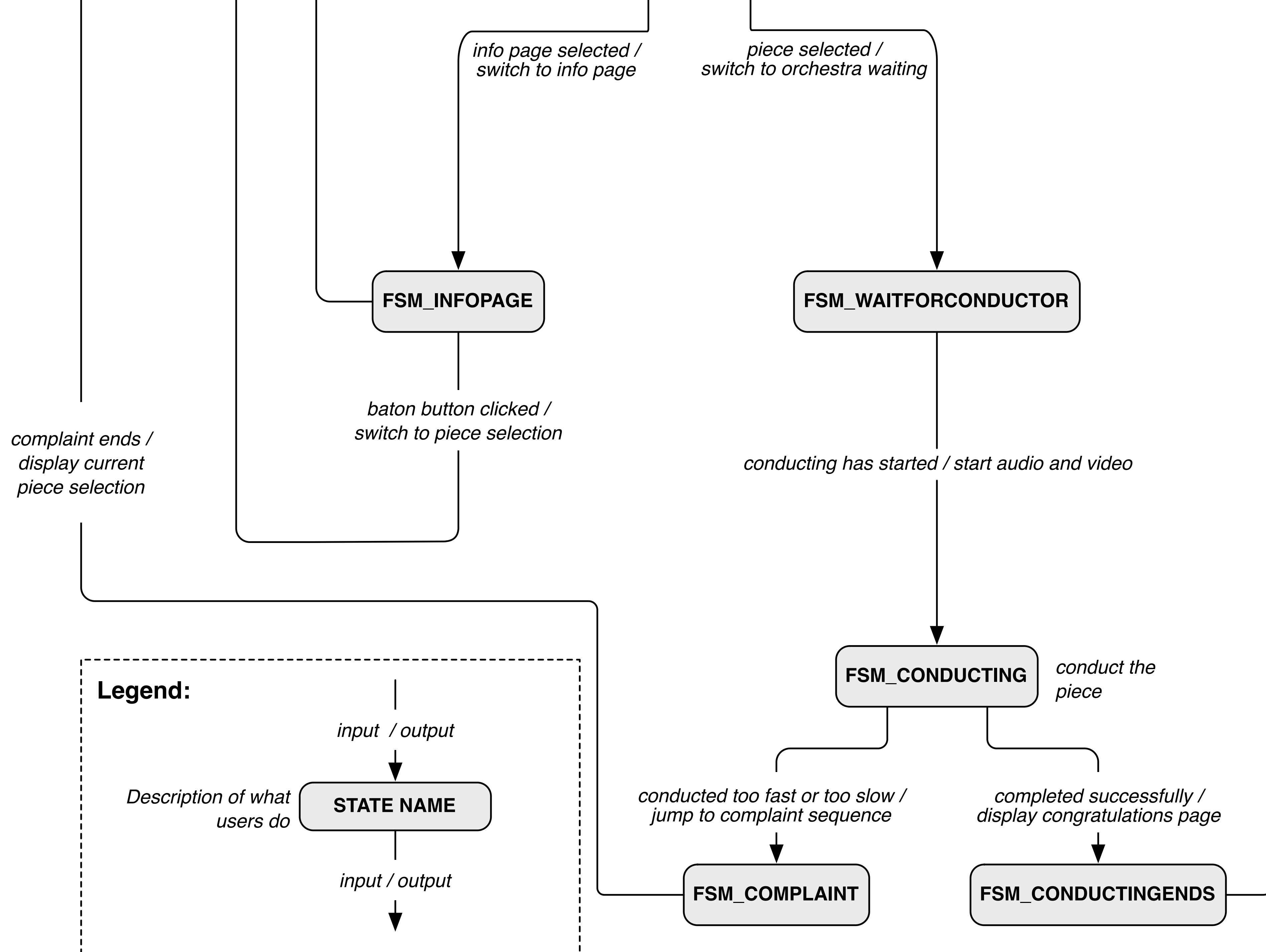

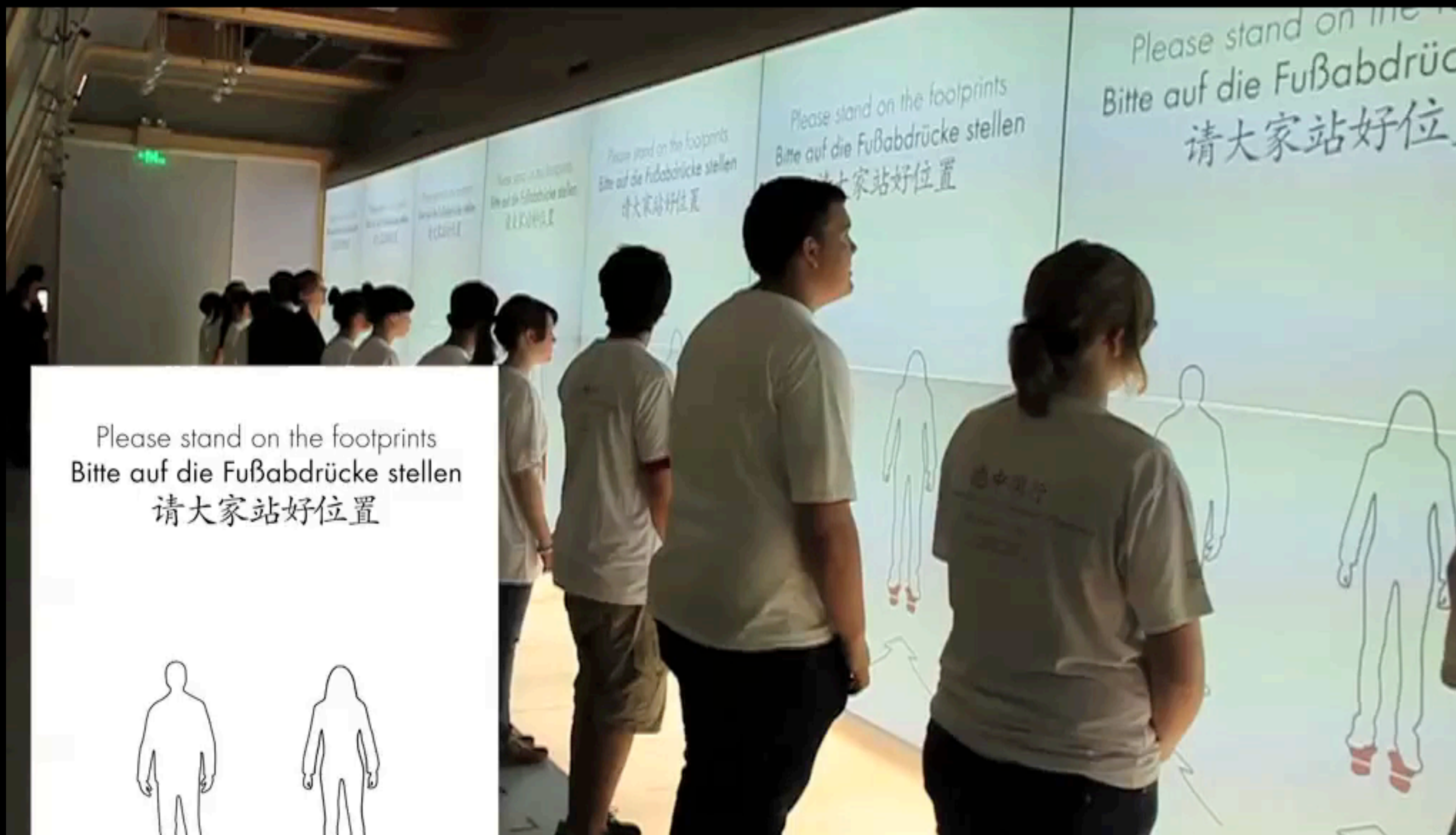

Please stand on the footprints
Bitte auf die Fußabdrücke stellen
请大家站好位置

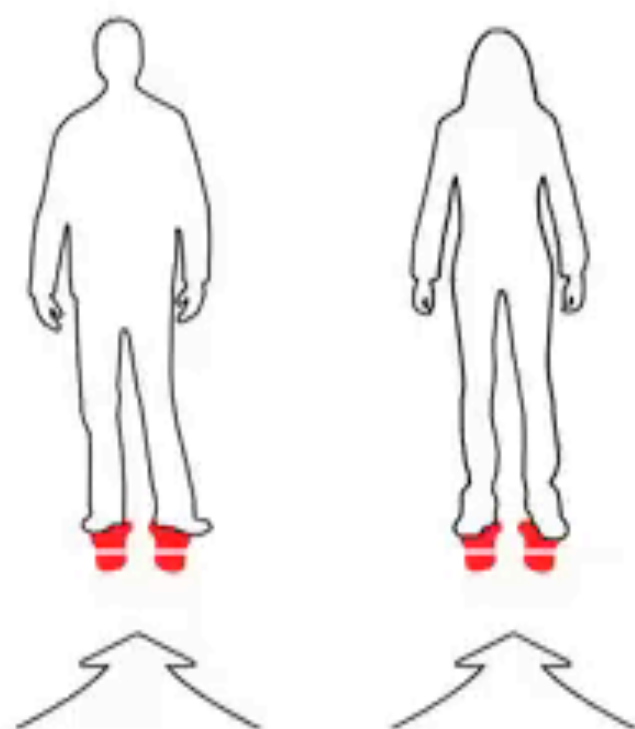

Silhouettes Components

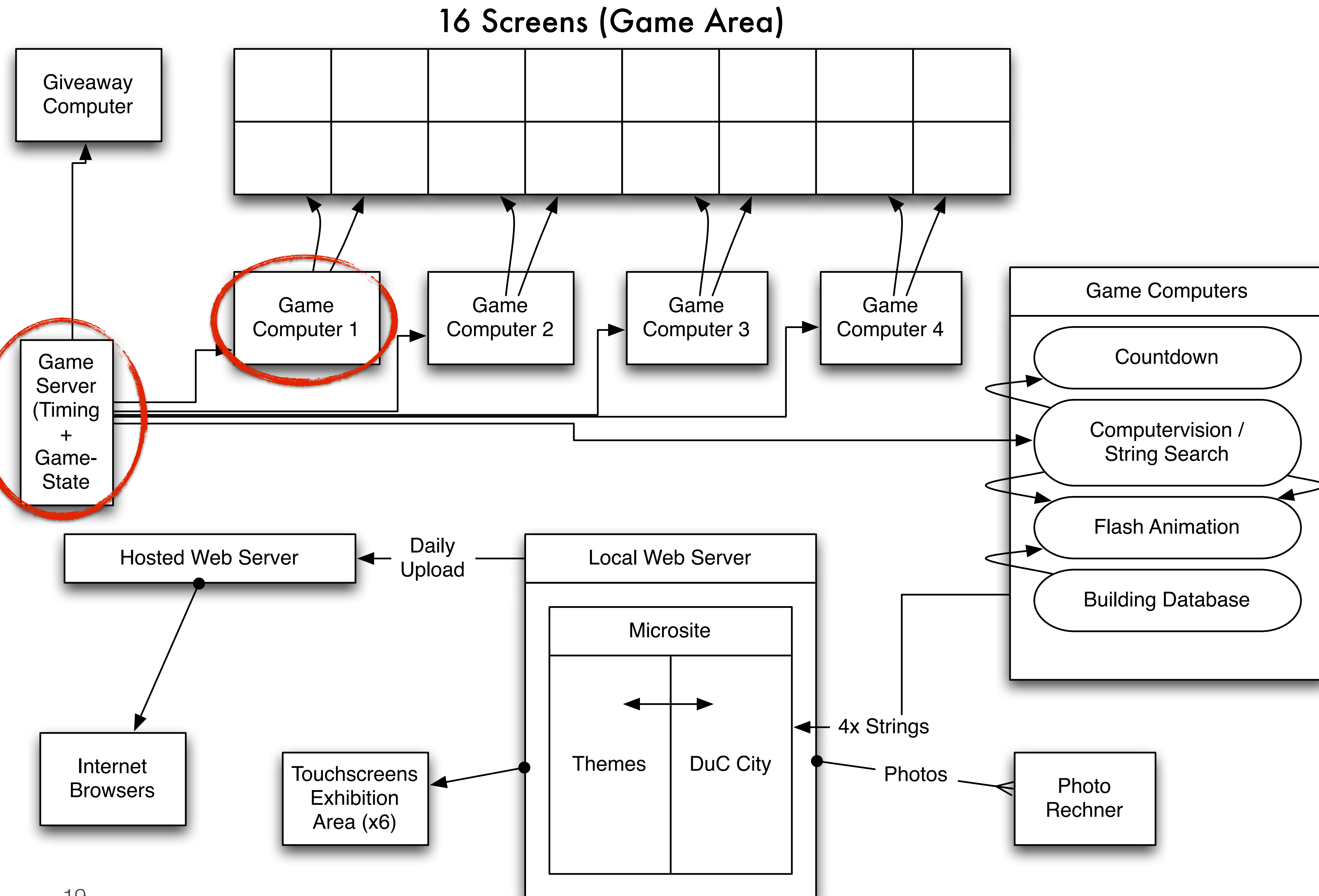

Silhouettes: Server STN

- Unconventional notation (agreed upon in the team)

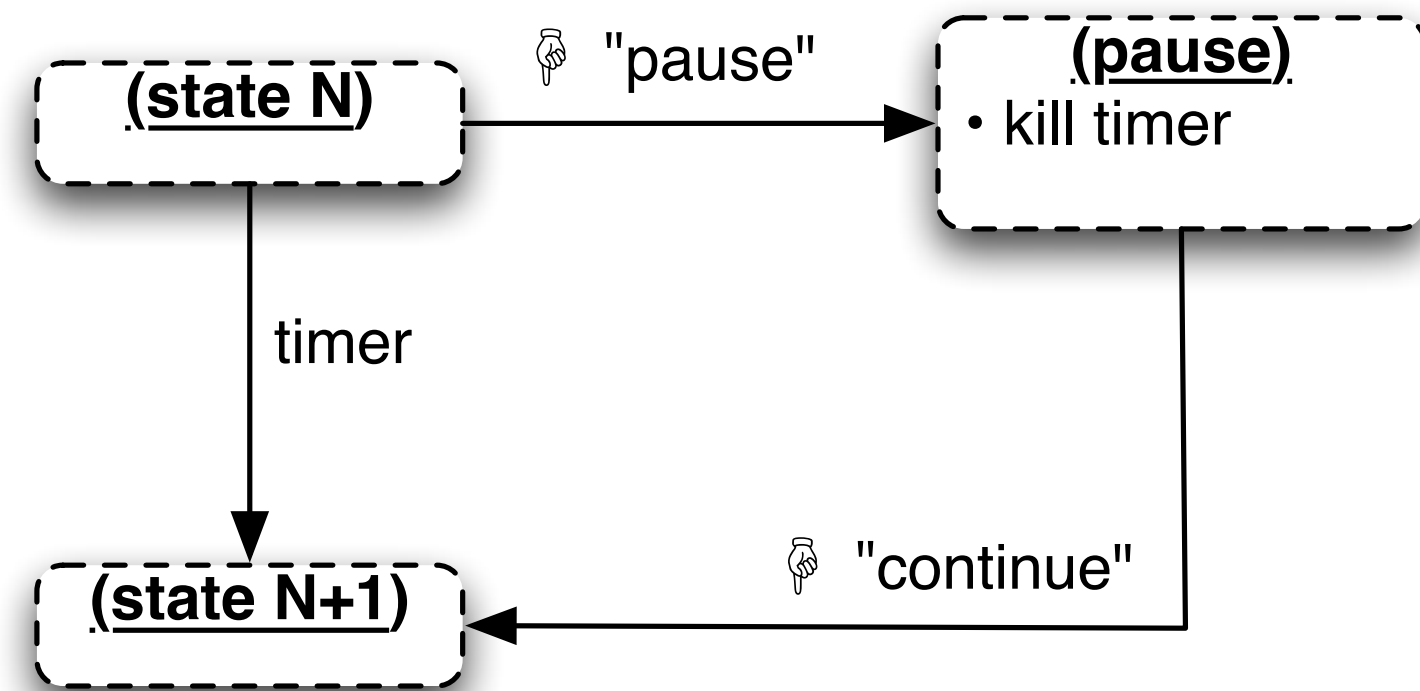

Legend:

⤴ : operator pushes button

Note:

- server is responsible to fade sound in each state

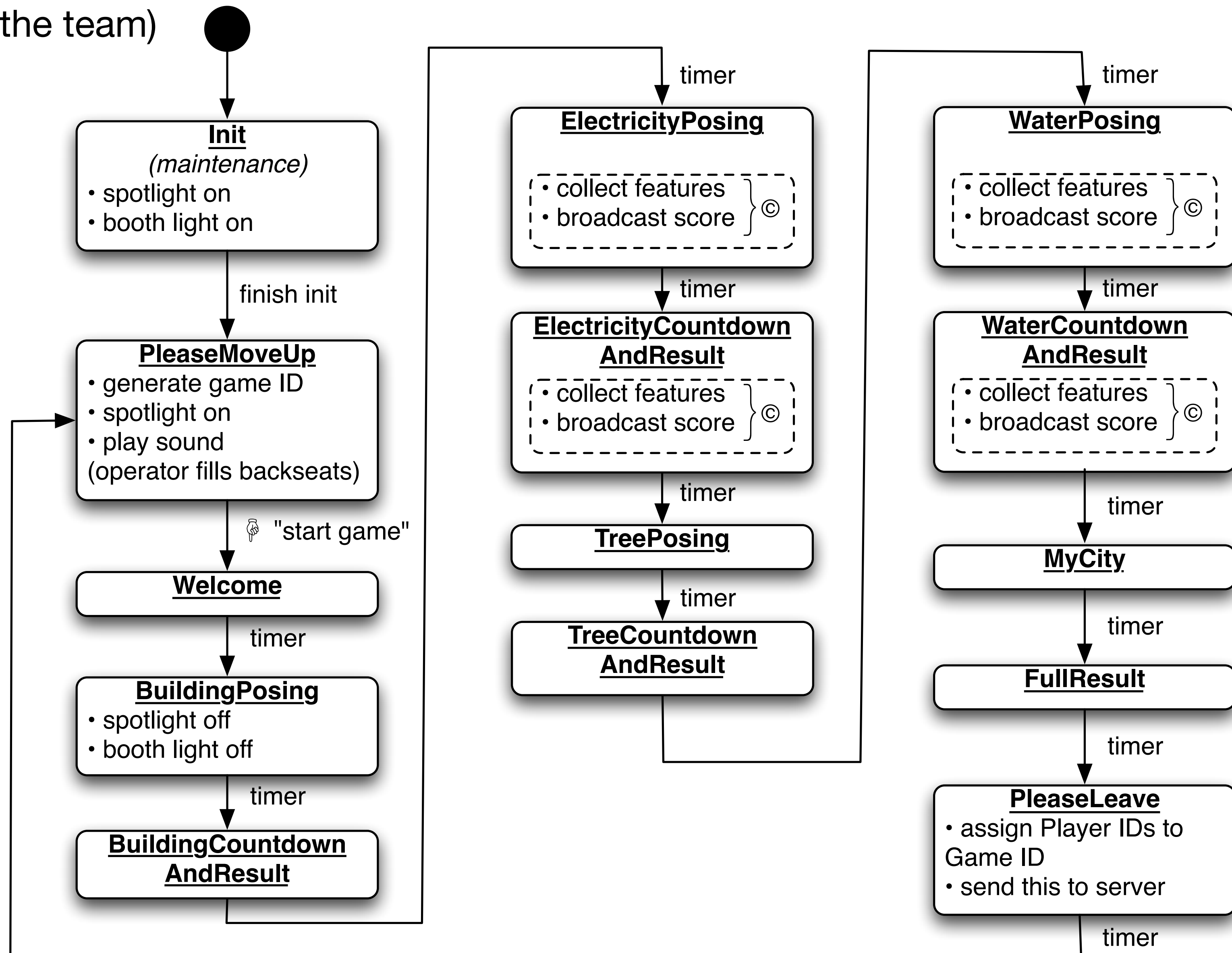

Silhouettes: Client STN

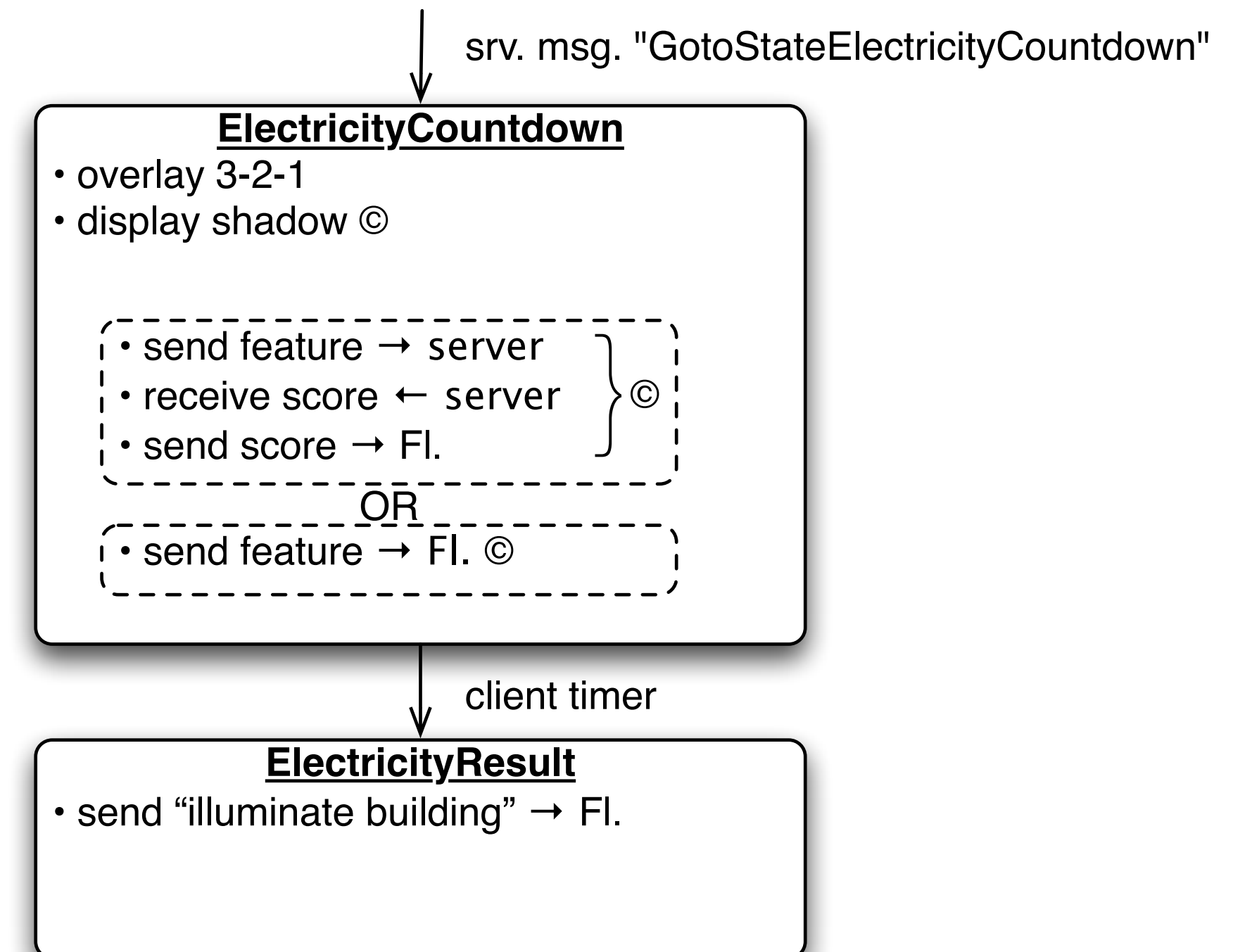
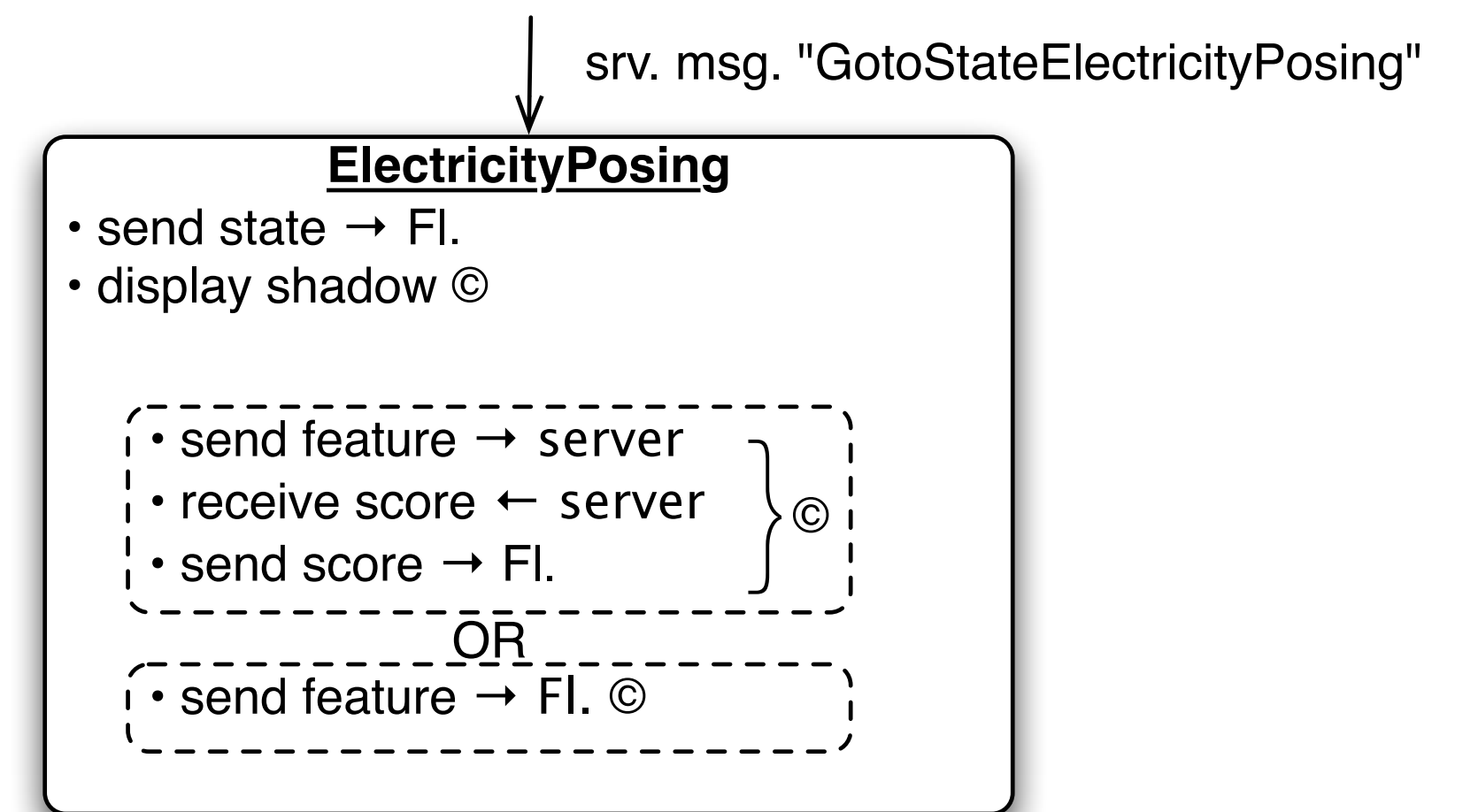
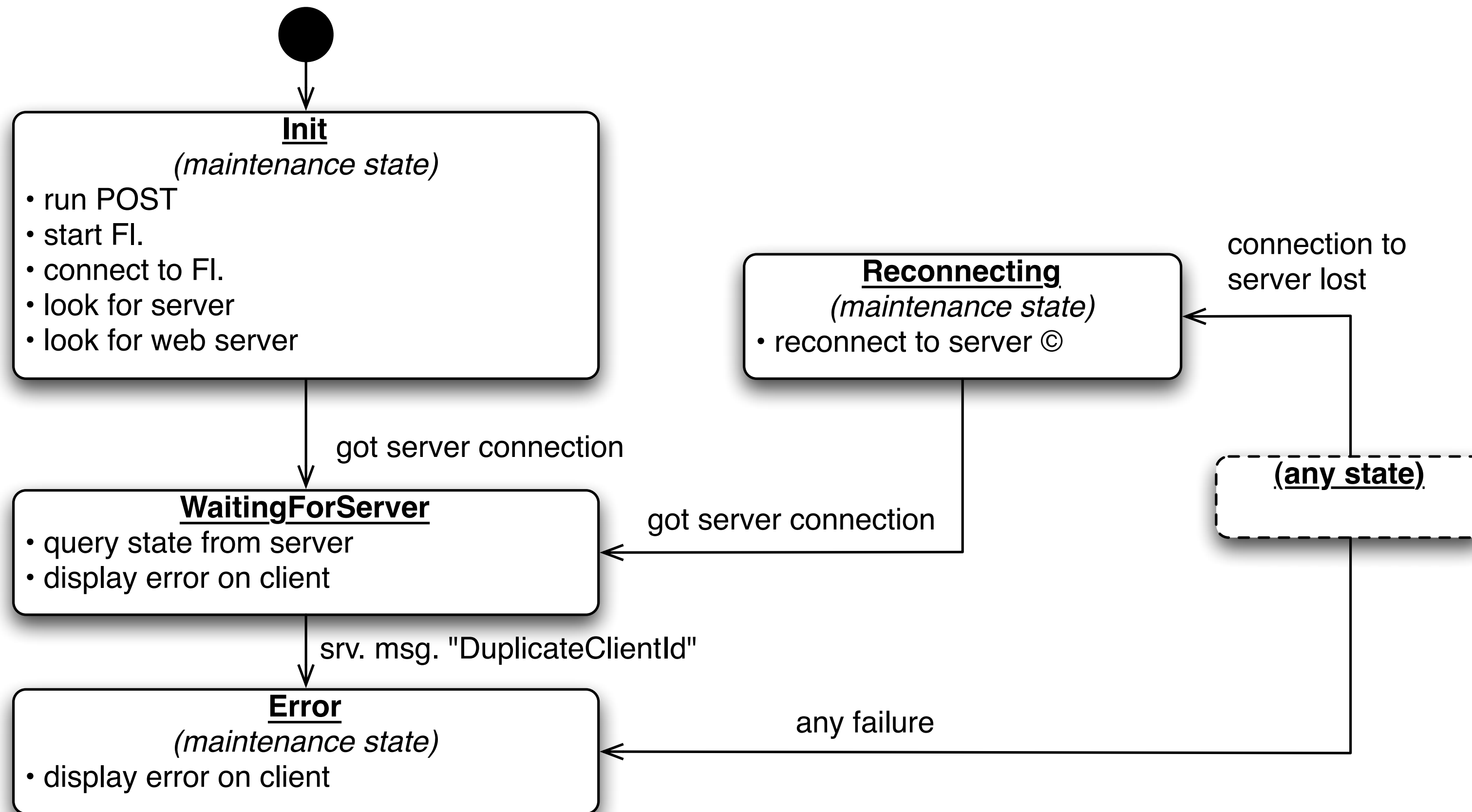
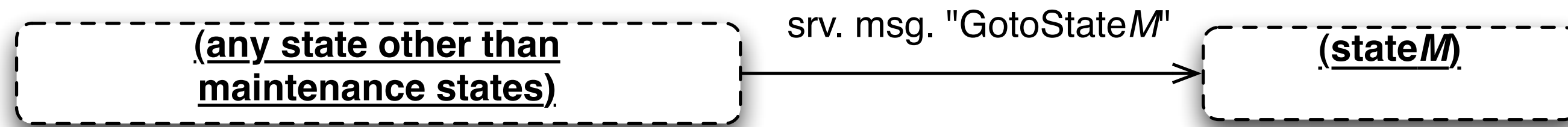

Visuals	Description	Server State/Action	Client State/Light
---------	-------------	---------------------	--------------------

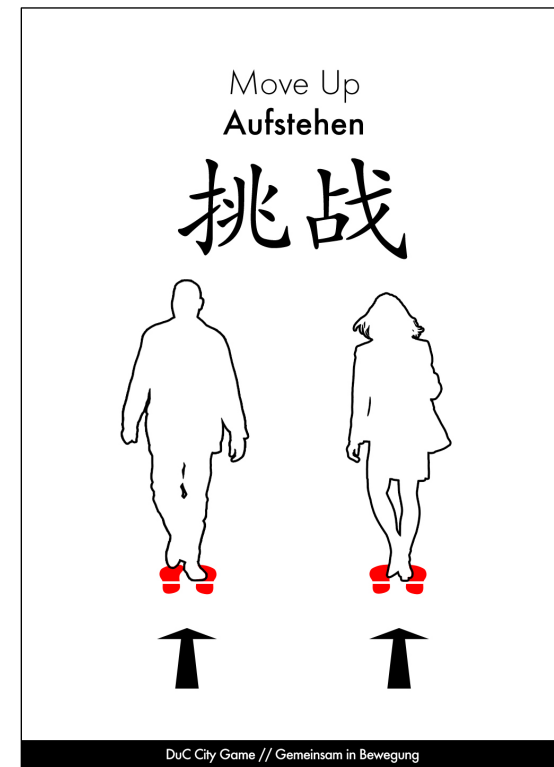

Waiting people will be asked to move up to the front and take their positions on the indicated spots.

PleaseMoveUp

- generate game ID
- spotlight on
- play sound (operator fill backseats)

DMX msg.
- fade **in** spots on indicated footprints on the floor

srv. msg.
"GotoStatePleaseMoveUp"

PleaseMoveUp

- send state → Fl.

"start game"
by button push



DMX msg.
- fade **out** spots on indicated foot prints on the floor
- fade **in** light in the waiting booths

Welcome

srv. msg.
"GotoStateWelcome"

Welcome

- send state → Fl.
- display mnemonics



DMX msg.
- fade **out** light in the waiting booths

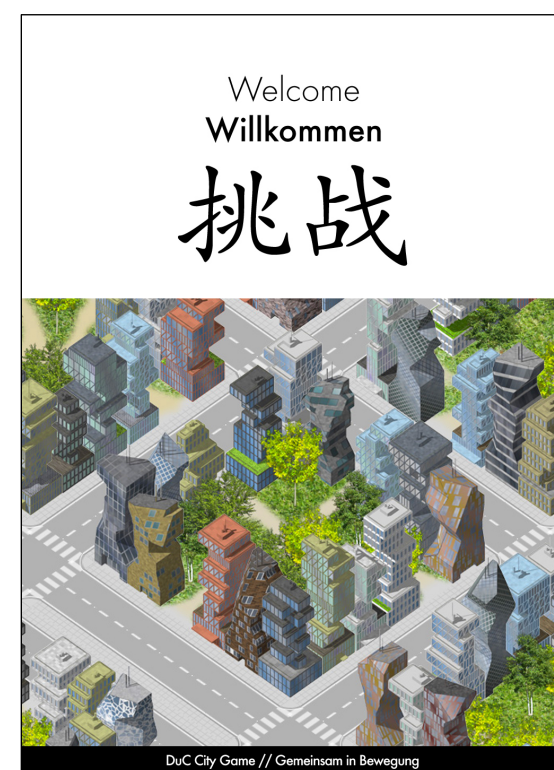

Playing people will be presented a welcome screen.

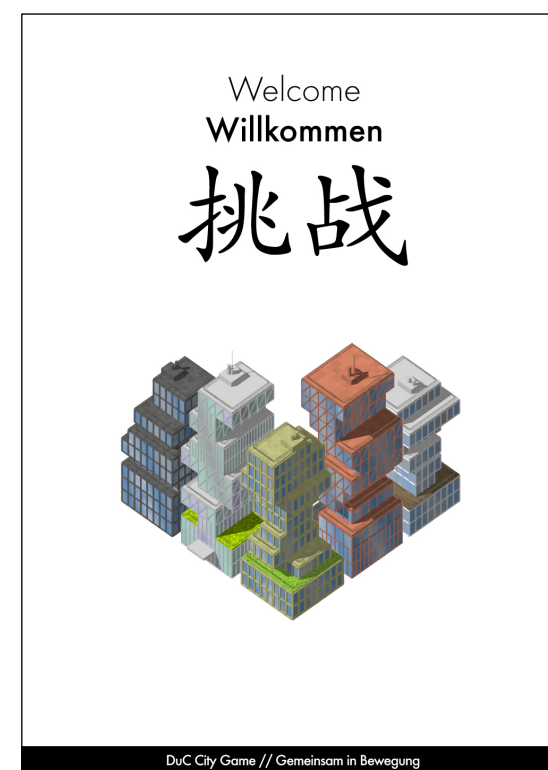

People from the outer waiting queue will take their seats in the inside waiting booths.



Iconic illustrations will remind the player how to create buildings by their shadows.

People will see their shadows while posing in front of the screens.

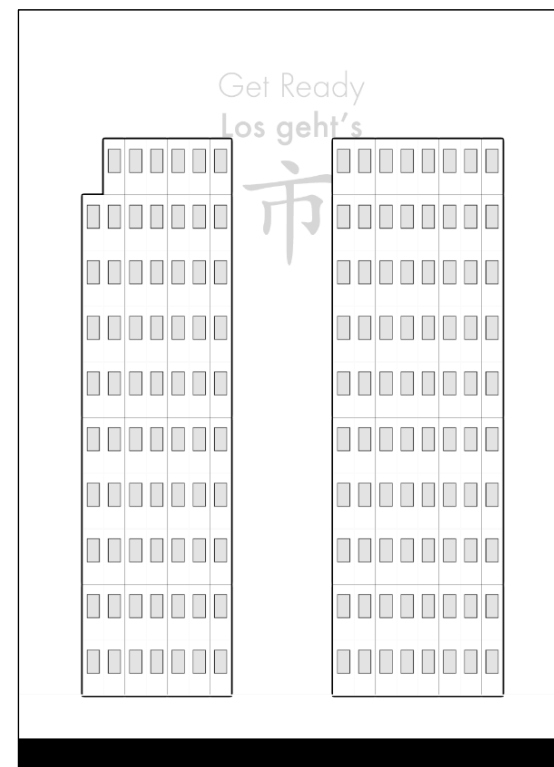

A countdown will indicate that shadows will be "frozen".

People will see the representation of their shadows as buildings.

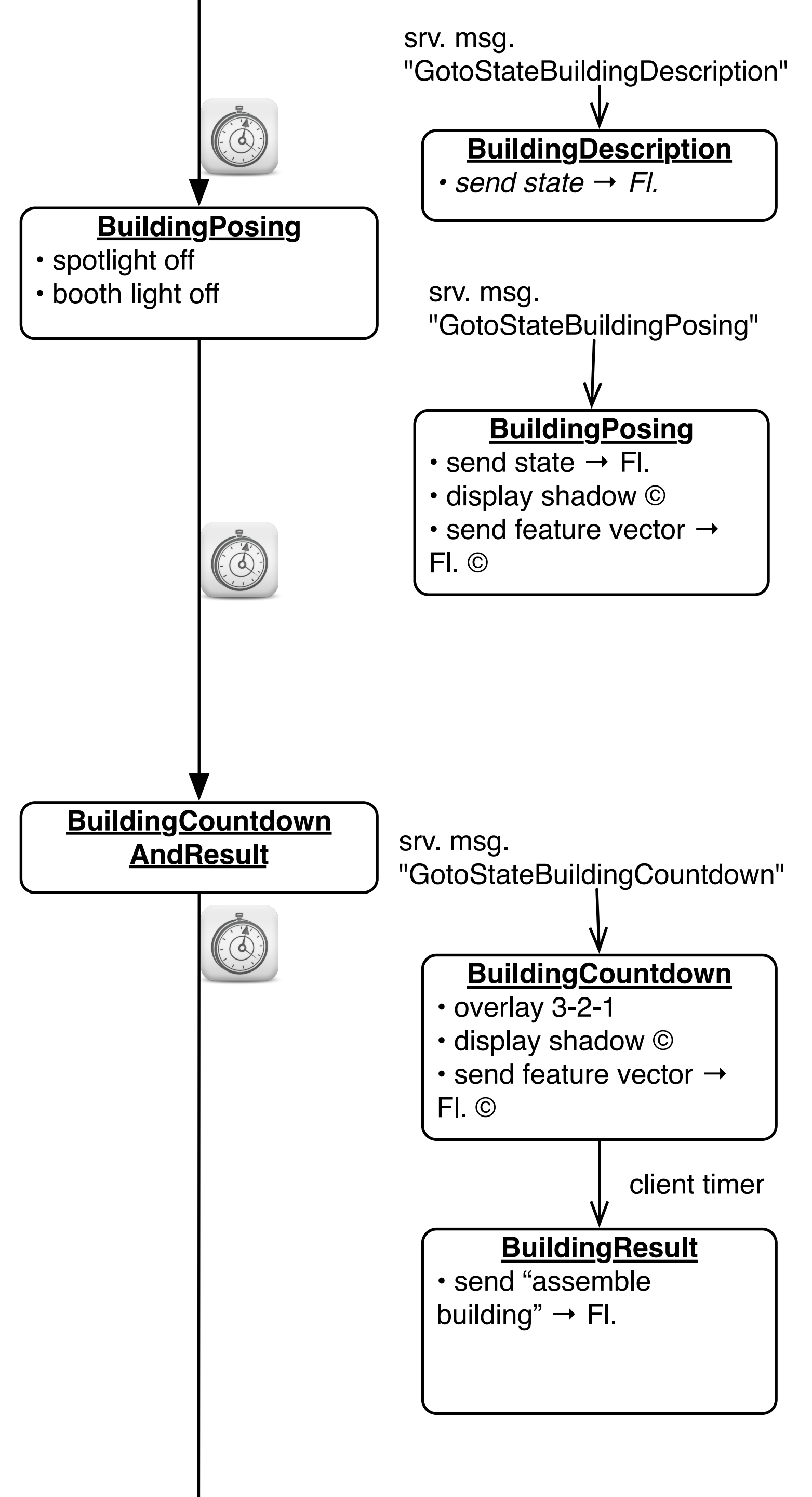

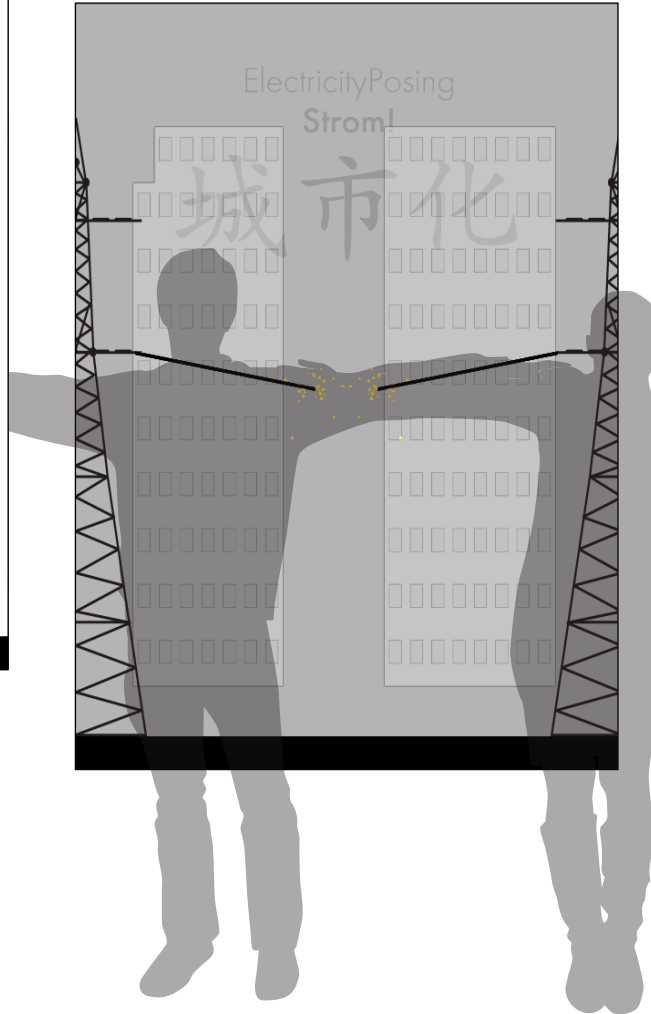
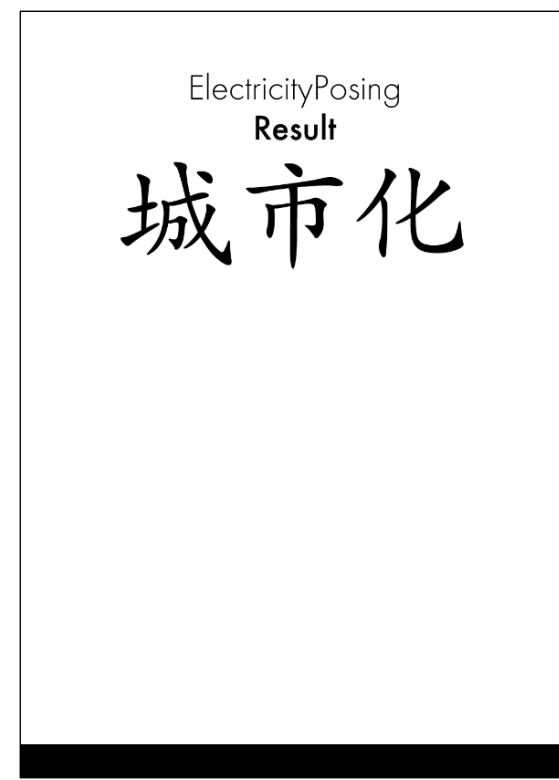

Iconic illustrations will remind the player how to pose in order to have their shadows overlap and thus create a power line.

People will see their shadows while posing in front of the screens.



A countdown will indicate that shadows will be "frozen".

People will see illuminated buildings in 4 different versions??

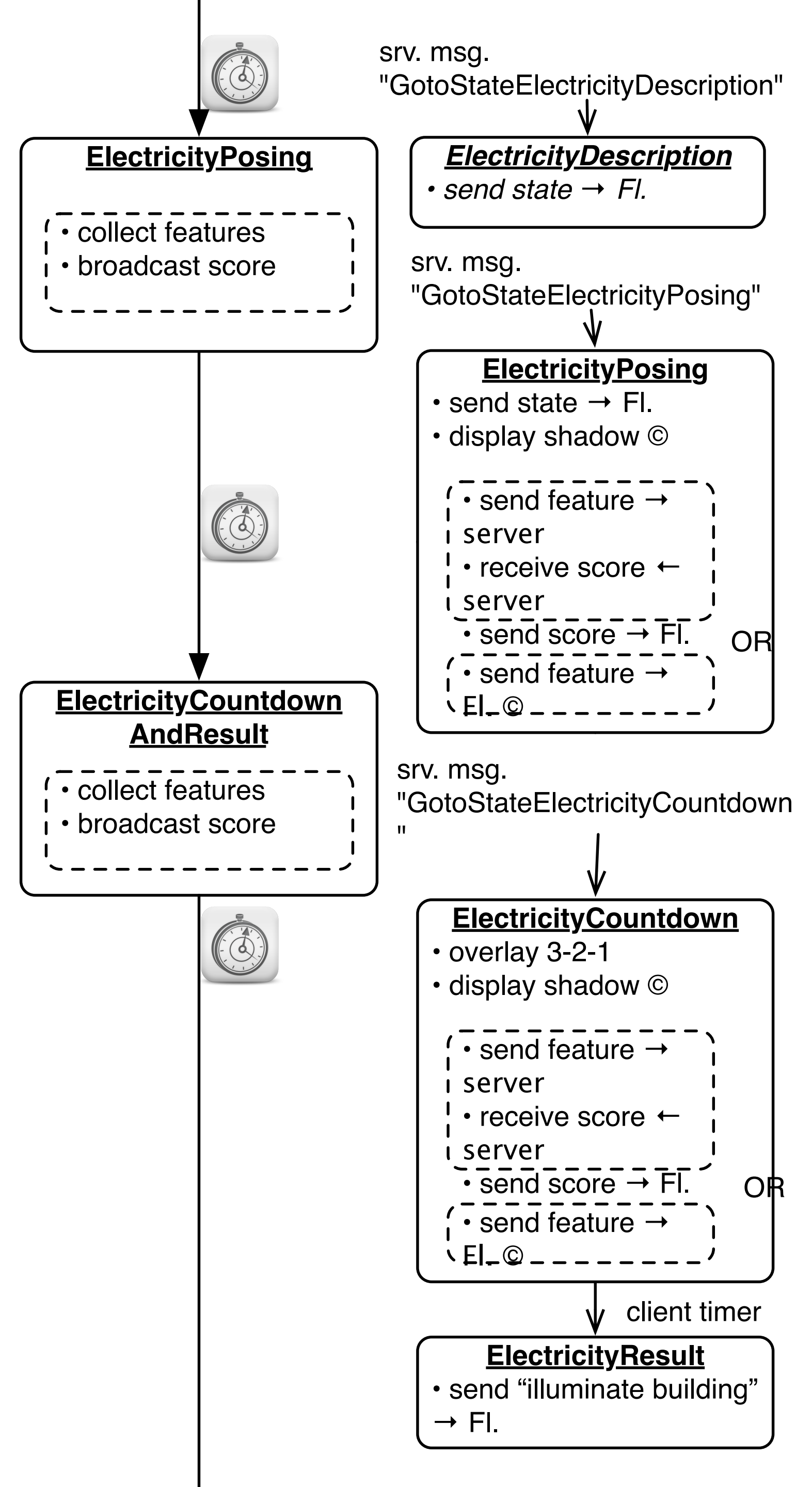
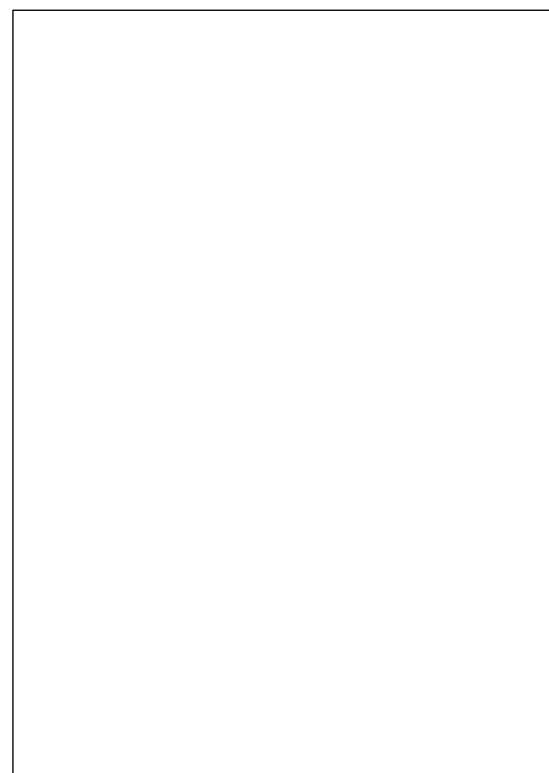



Iconic illustrations will remind the player how to create trees by their shadows.

People will see their shadows while posing in front of the screens.

A countdown will indicate that shadows will be "frozen".

People will see the representation of their shadows as trees.

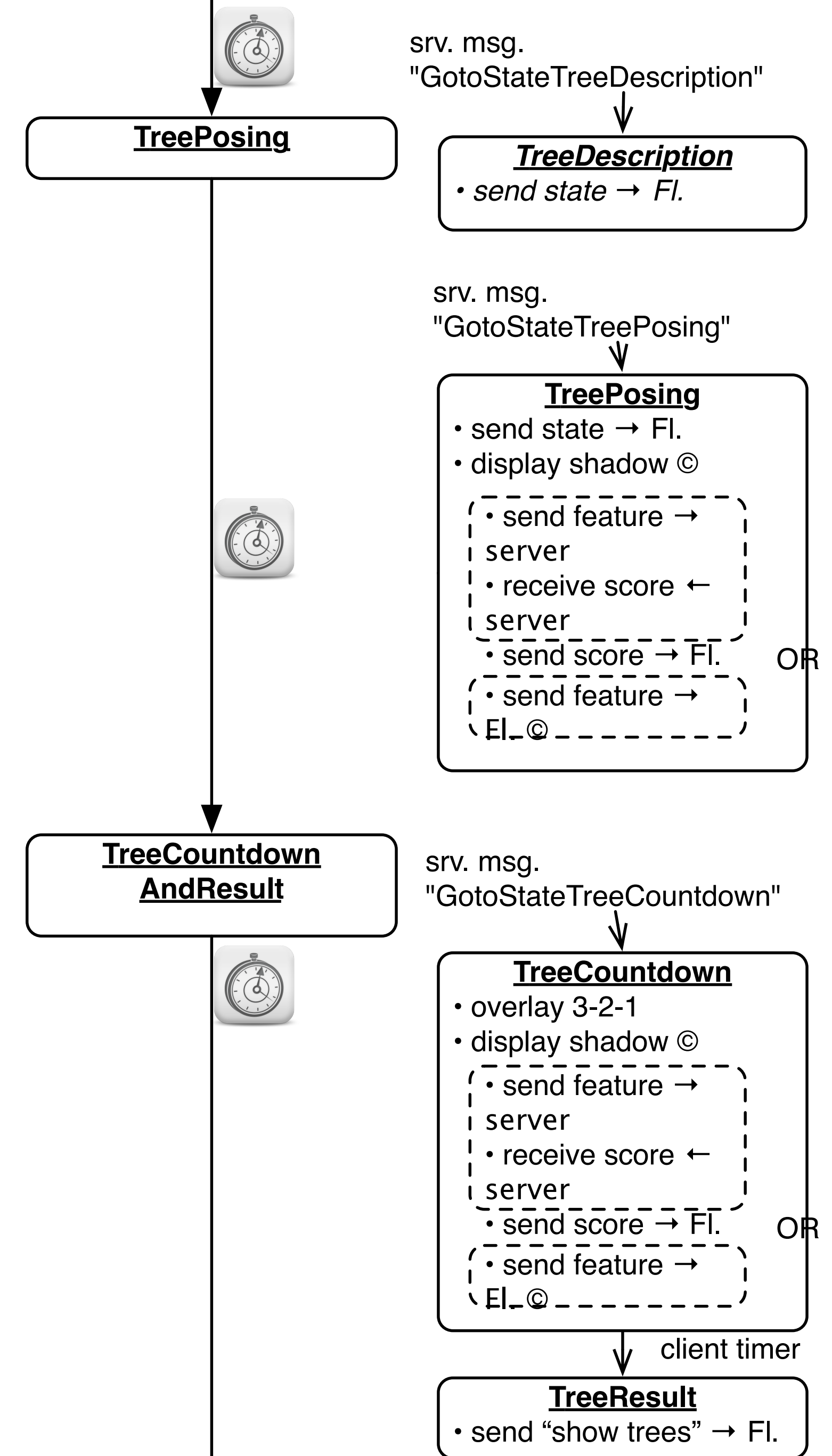

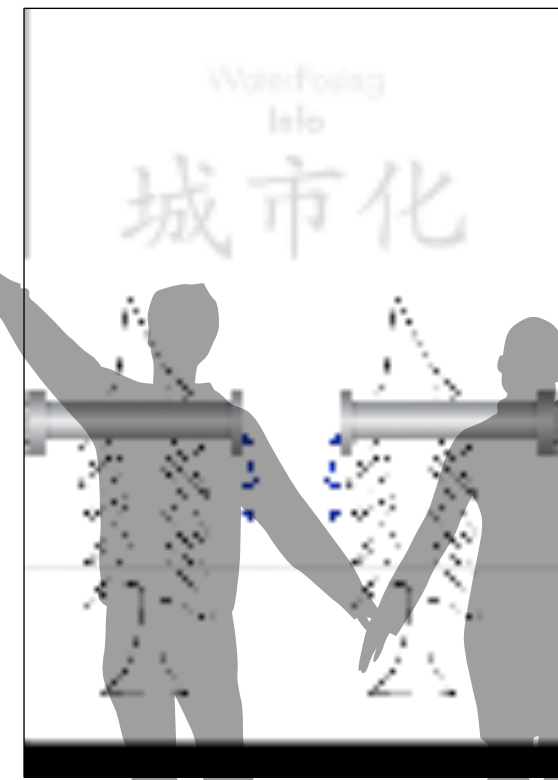

Iconic illustrations will remind the player how to pose in order to have their shadows overlap and thus create a water line.

People will see their shadows while posing in front of the screens.



A countdown will indicate that shadows will be "frozen".

People will see the trees that they created with different green colours/trees with leaves?

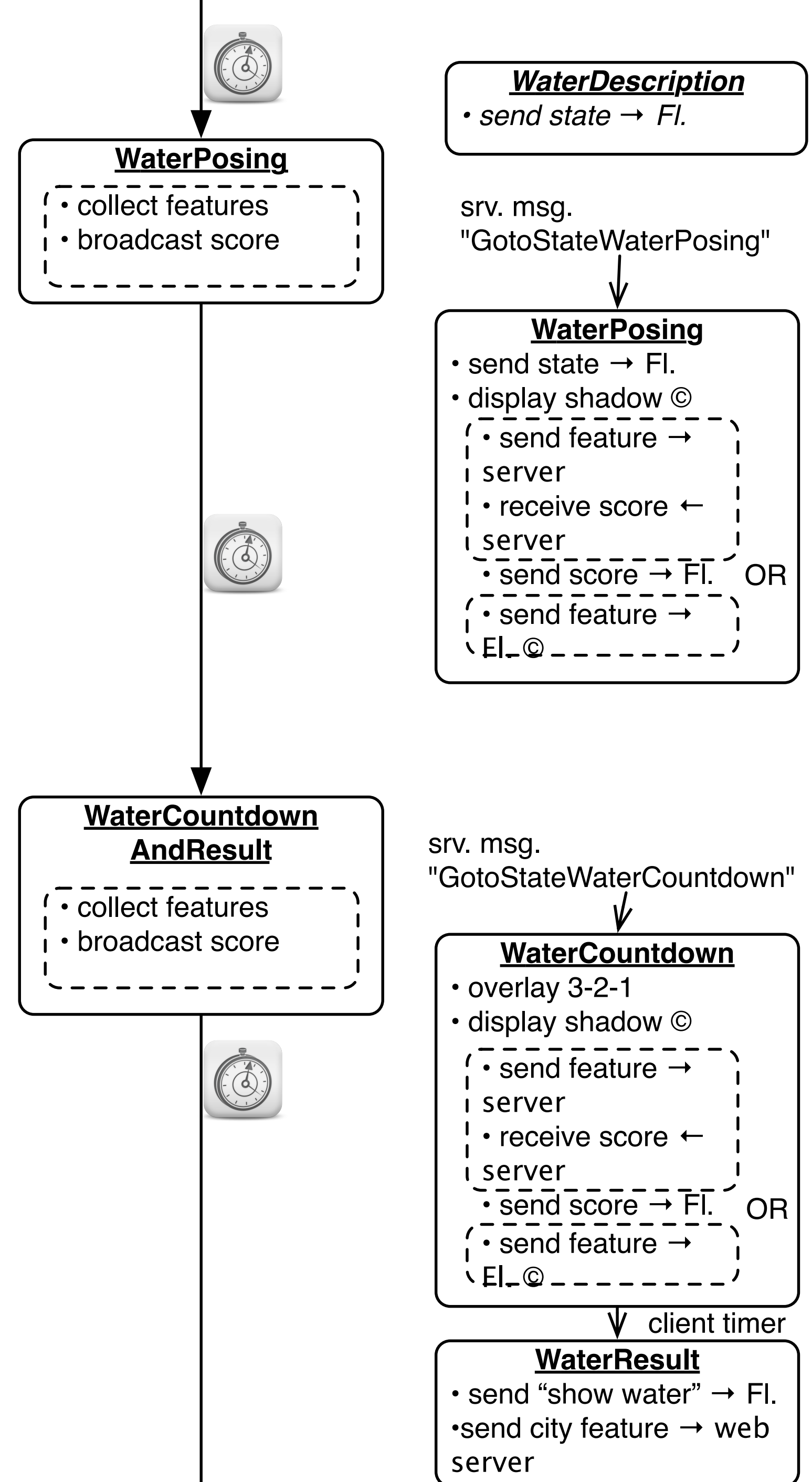

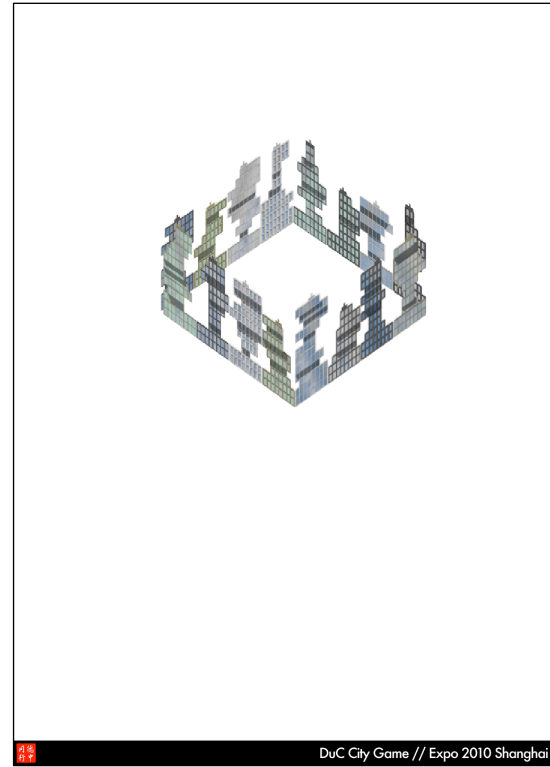

People will see a animation of what will happen with their skyline.

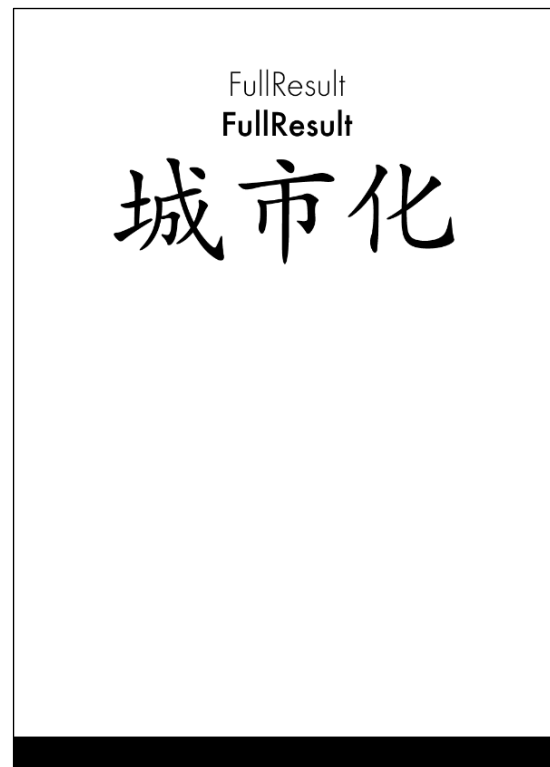

People will see their city block with the block number and the URL of the DuC Website.

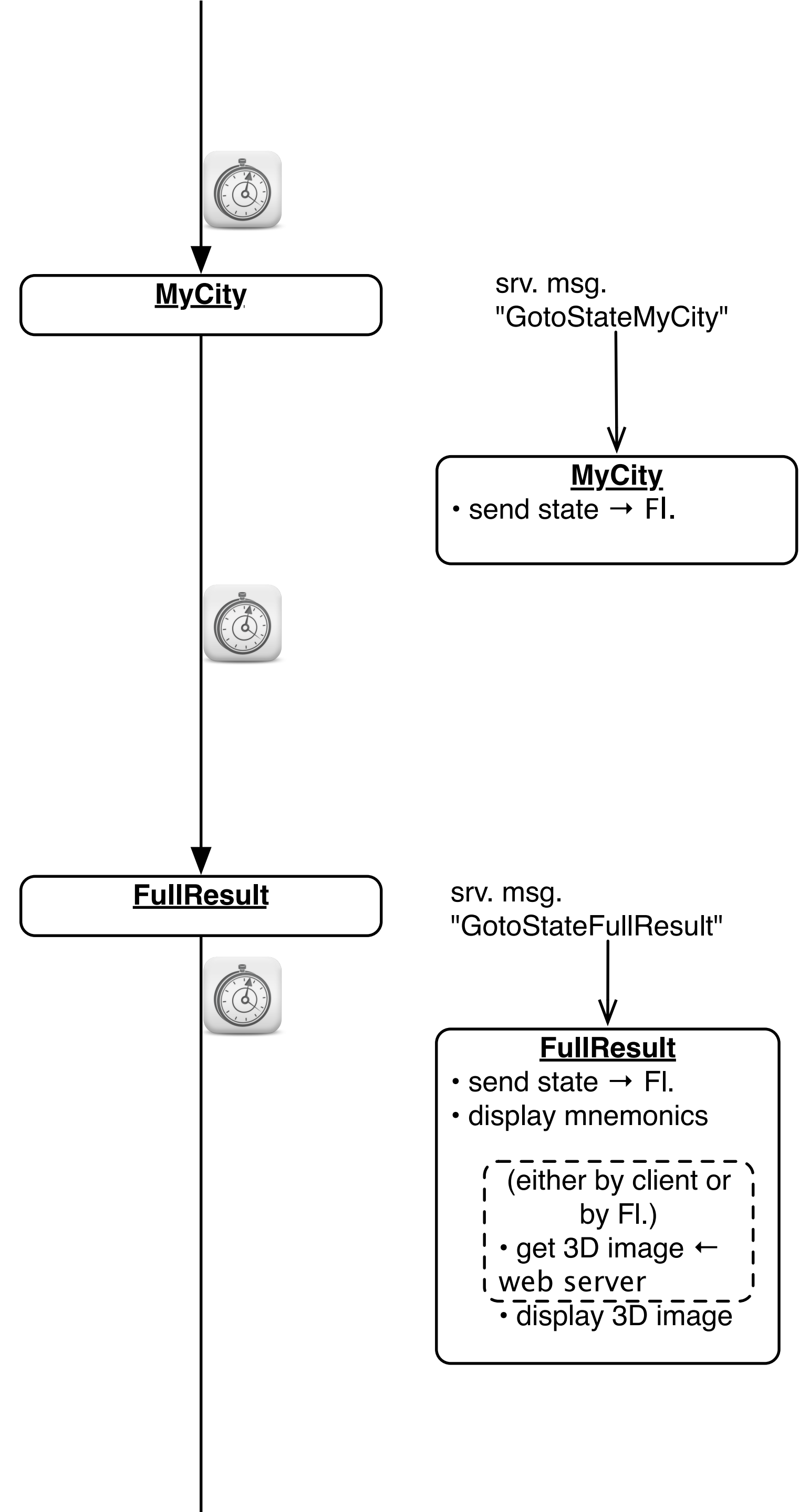



People will be asked to move out.

Beyond the playing area, visitors can deepen their understanding of city concepts at individual interactive stations before leaving the pavilion.



PleaseLeave

- assign Player IDs to Game ID
- send this to server

srv. msg.
"GotoStatePleaseLeave"



PleaseLeave

- send state → Fl.

Hierarchical STNs

- **Start** and **Finish** states serve to glue an STN for a sub dialog (e.g., a certain menu selection) into a larger dialog (e.g., operating the application in general)
- Same expressive power as STNs, just more convenient
- The dialog structure of an entire system can be specified this way

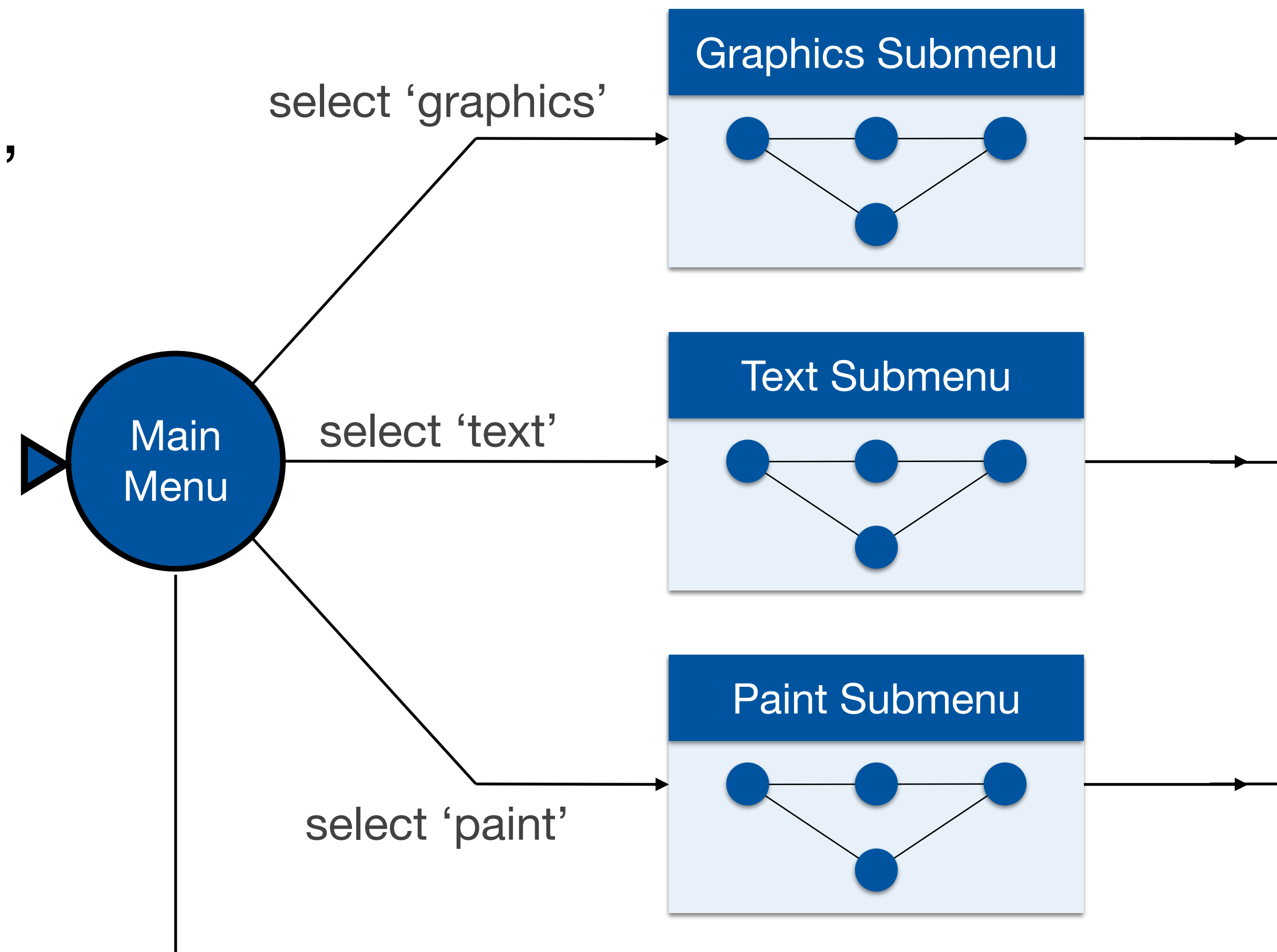

Using STNs in Prototyping

- Create a simple STN for the dialogs envisioned
- Create one UI snapshot (sketch if paper prototype) per state (label it with the state name)
- Include offscreen area for annotations and to include extra buttons simulating user actions that do not correspond to simple clicks on the current screen
- When walking the user through your paper prototype, consult the STN to find out how to respond to each user action

Using STNs in Prototyping

- Alternative: Let the computer “execute” the STN to run the prototype
- Use tools such as Keynote, PowerPoint



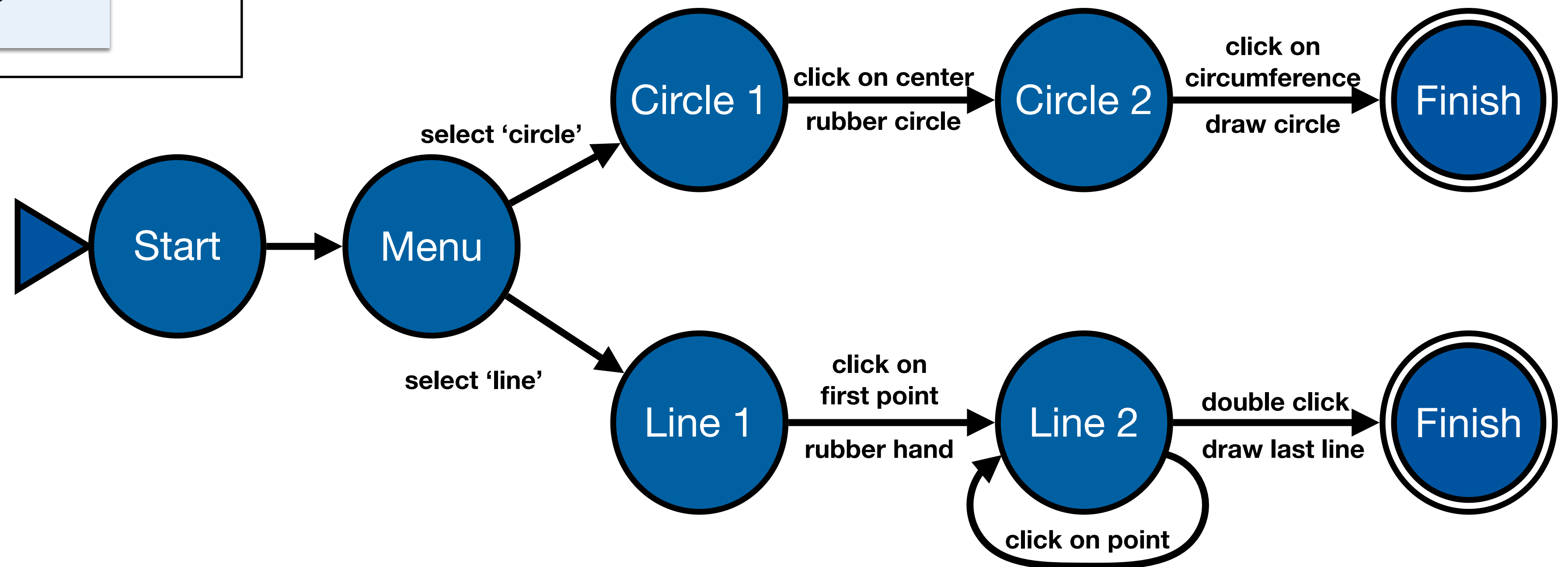
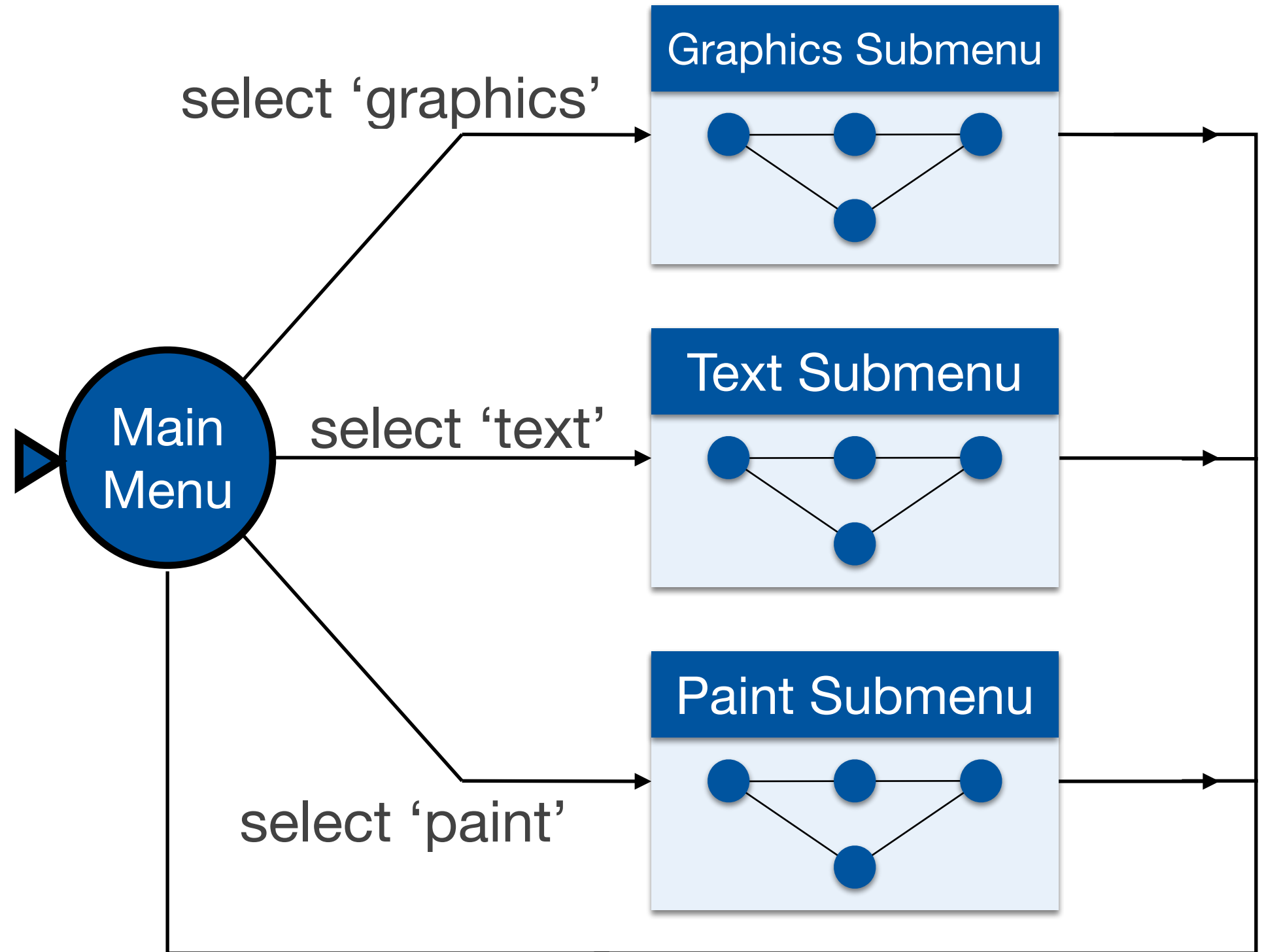

Using STNs in Prototyping

Adapted from “Human–Computer Interaction” by Dix, Finlay, Abowd, and Beale, Chapter 8

Current state:

Main Menu

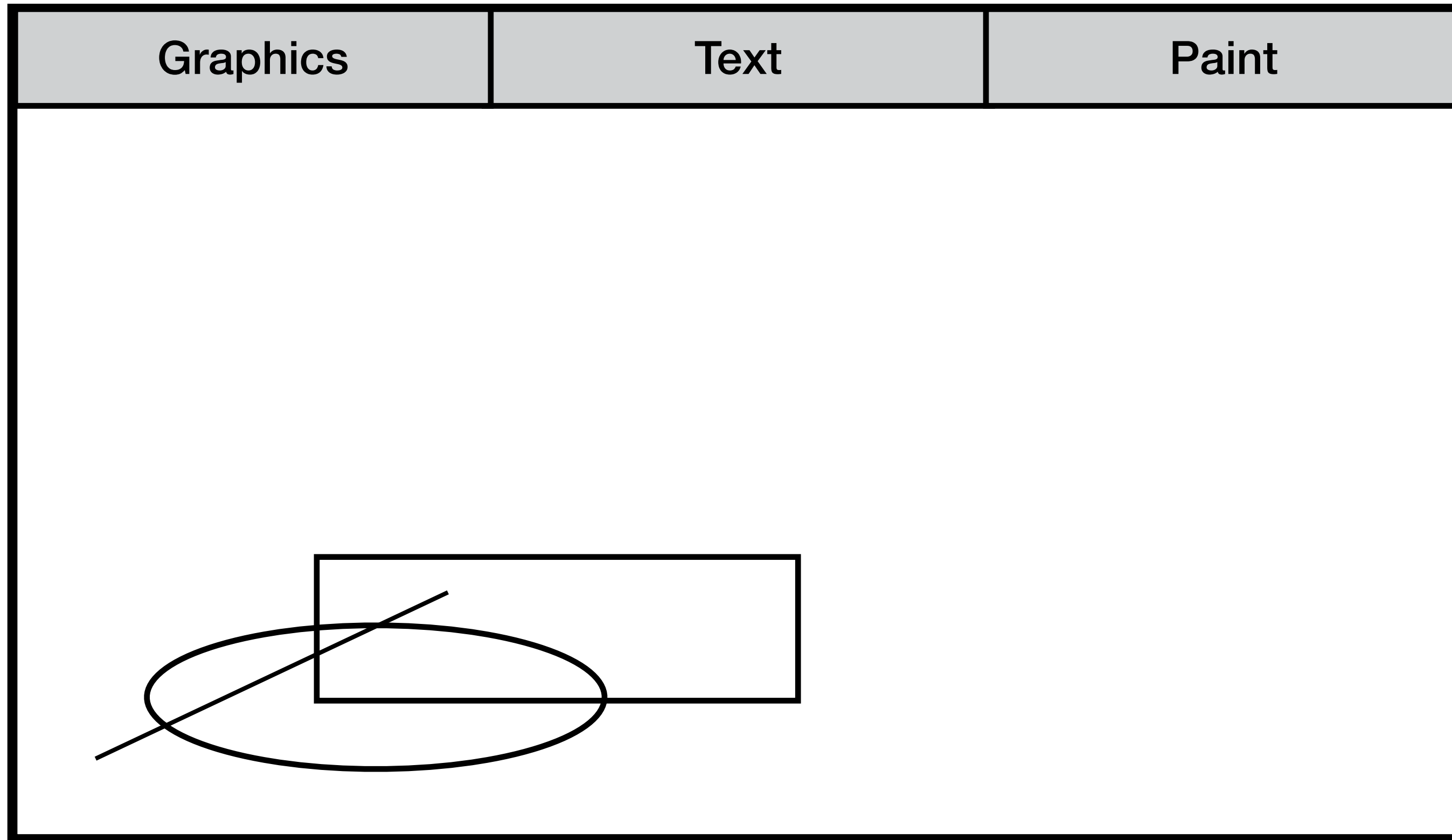

Using STNs in Prototyping

Adapted from “Human–Computer Interaction” by Dix, Finlay, Abowd, and Beale, Chapter 8

Current state:

Main Menu

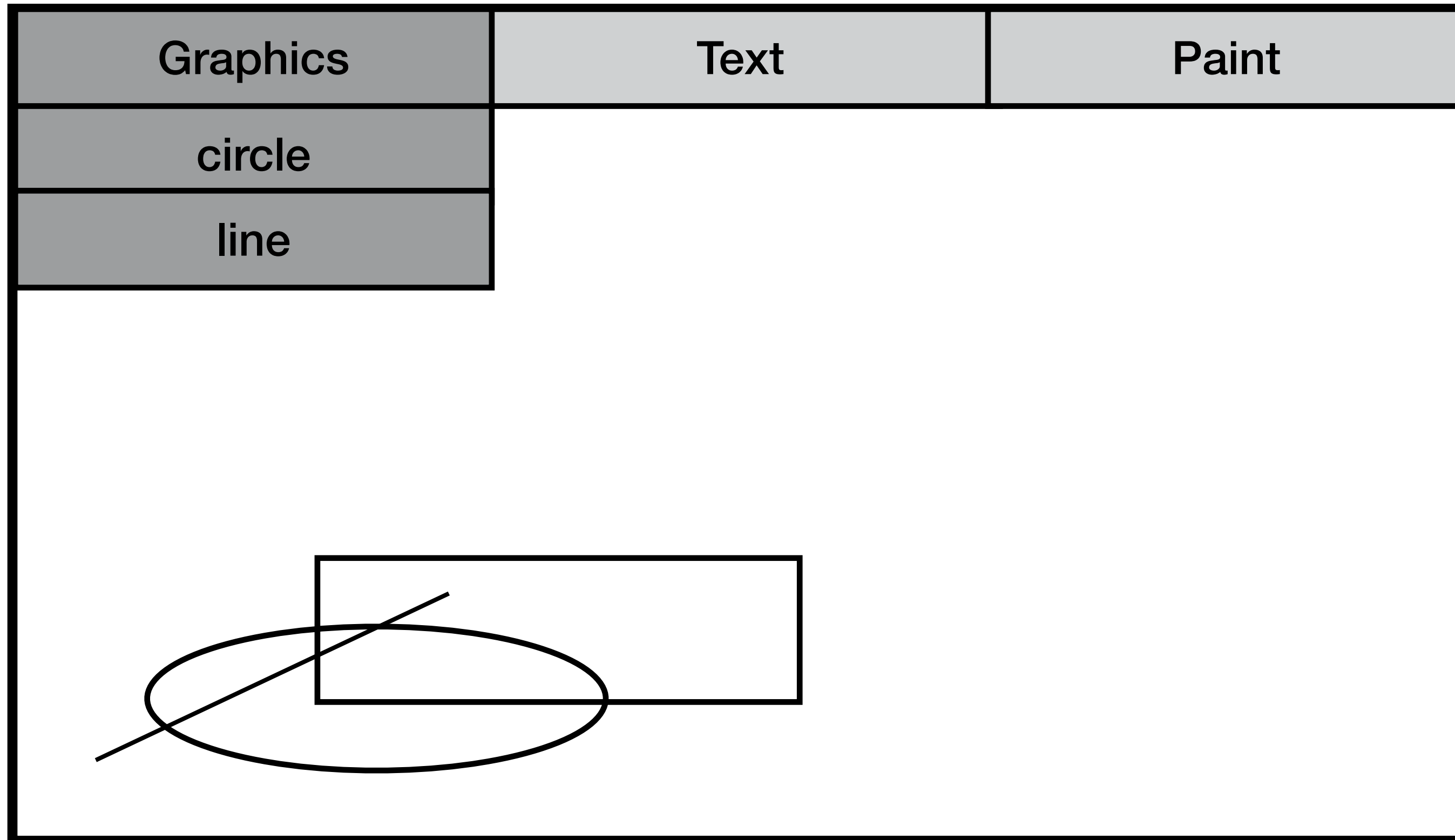

Using STNs in Prototyping

Adapted from “Human–Computer Interaction” by Dix, Finlay, Abowd, and Beale, Chapter 8

Current state:

Circle 1

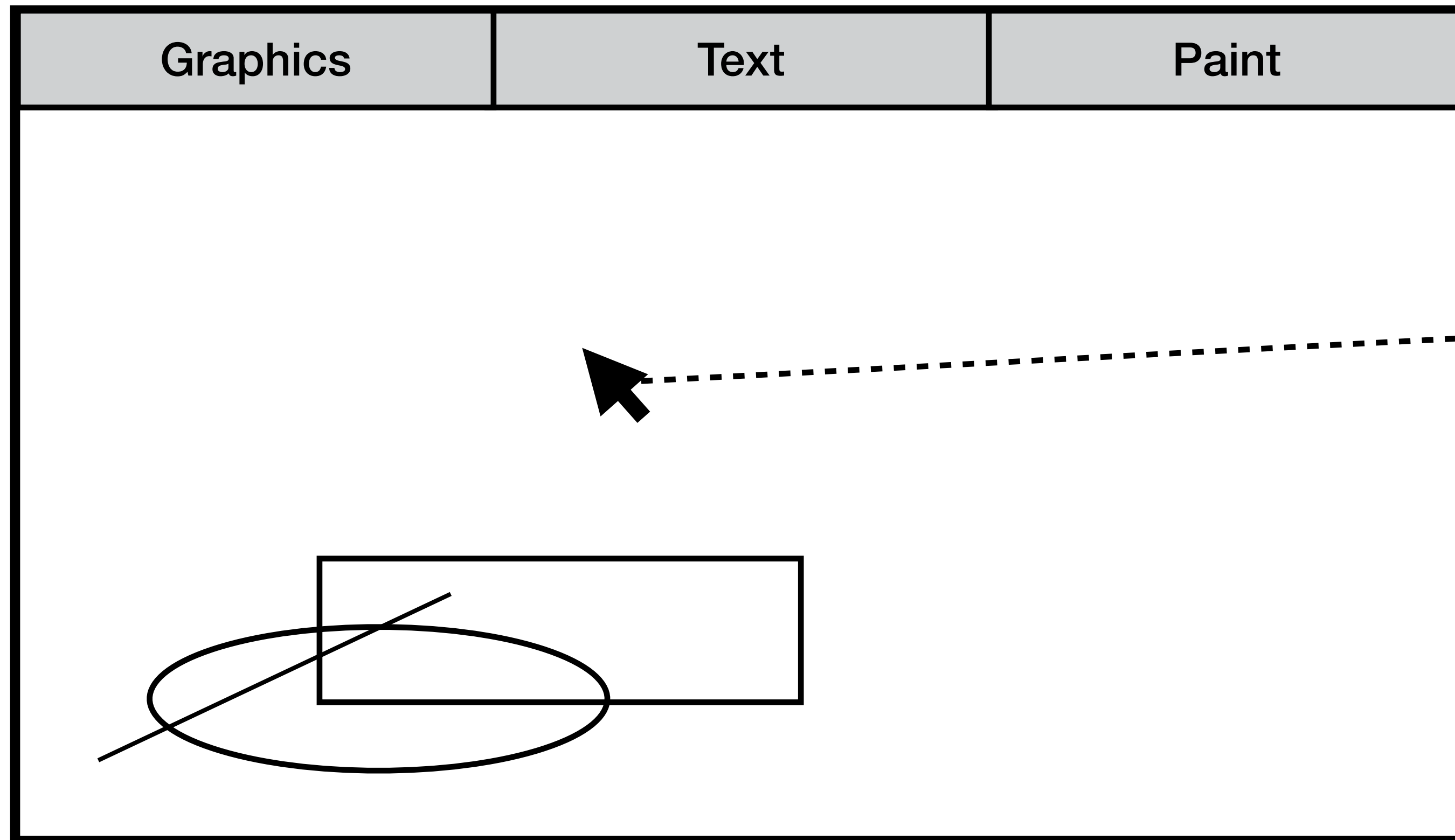

Click this button to simulate a click on the drawing area.

Click on Center

Using STNs in Prototyping

Adapted from “Human–Computer Interaction” by Dix, Finlay, Abowd, and Beale, Chapter 8

Current state:

Circle 2

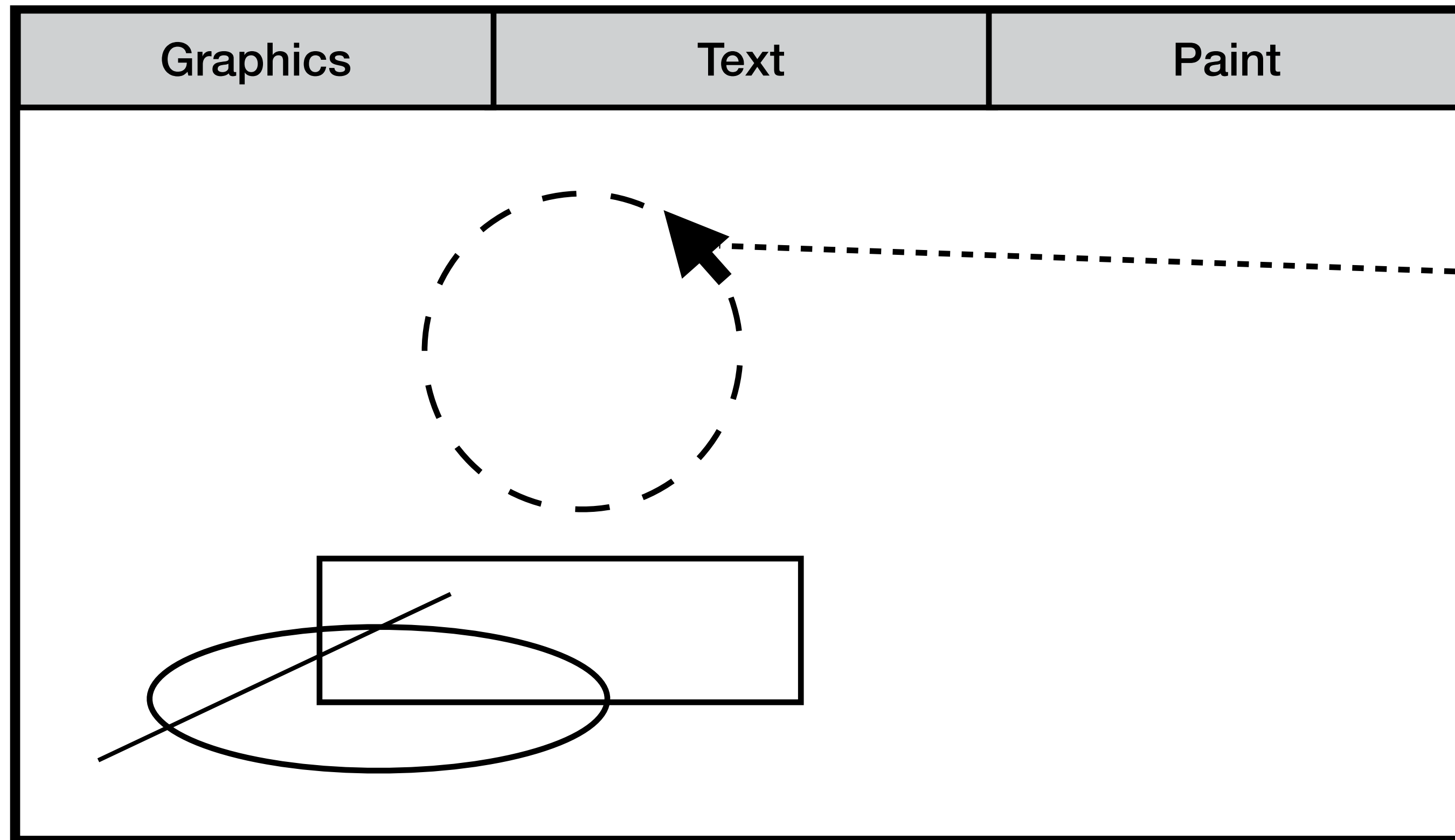

Click this button to simulate a click on the drawing area.

Click on Circumference

Using STNs in Prototyping

Adapted from “Human–Computer Interaction” by Dix, Finlay, Abowd, and Beale, Chapter 8

Current state: **End of Drawing**

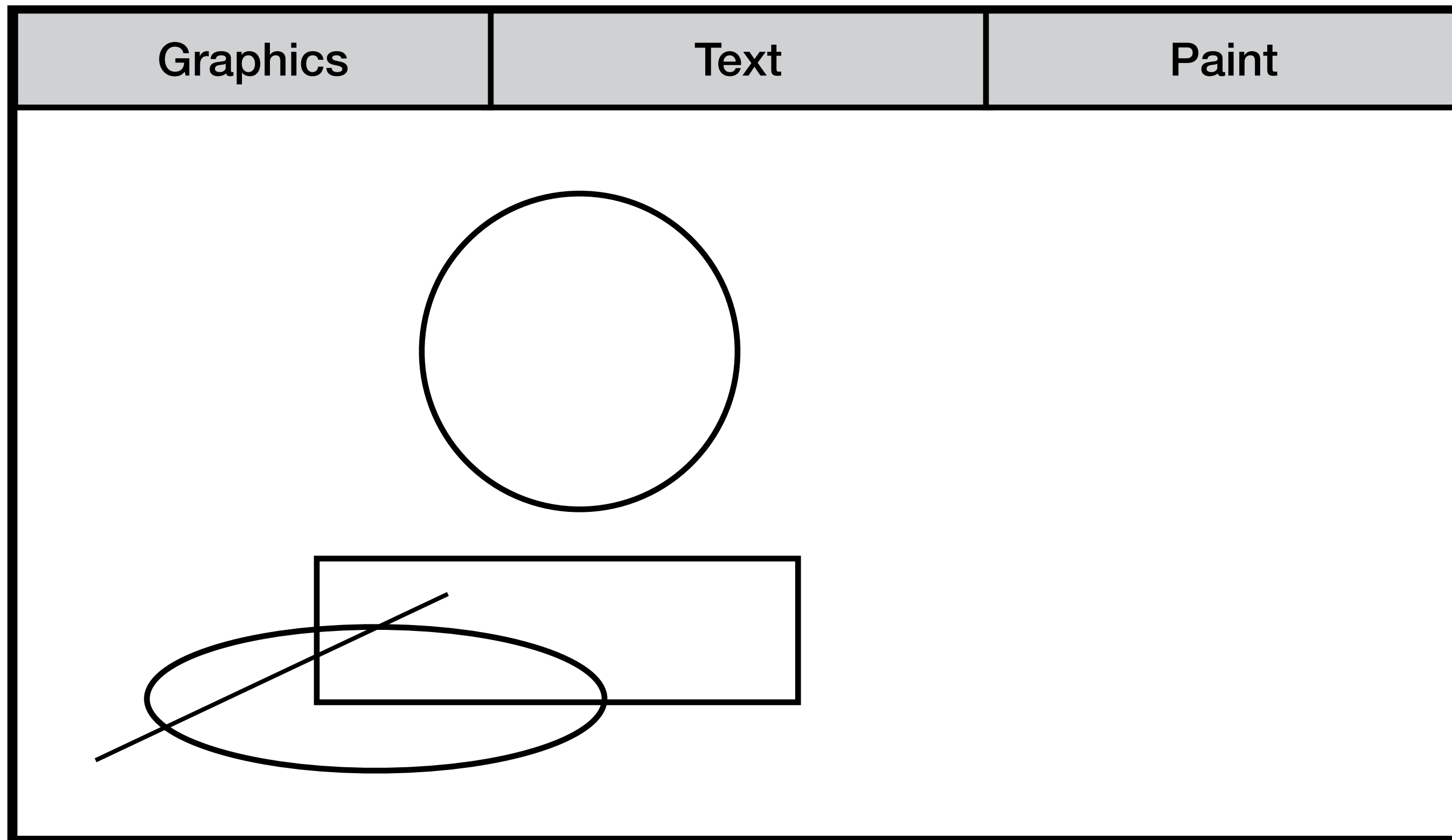

The circle is drawn now.
Click the button to go back to main menu.

Back to Main Menu

Using STNs in Prototyping

Adapted from “Human–Computer Interaction” by Dix, Finlay, Abowd, and Beale, Chapter 8

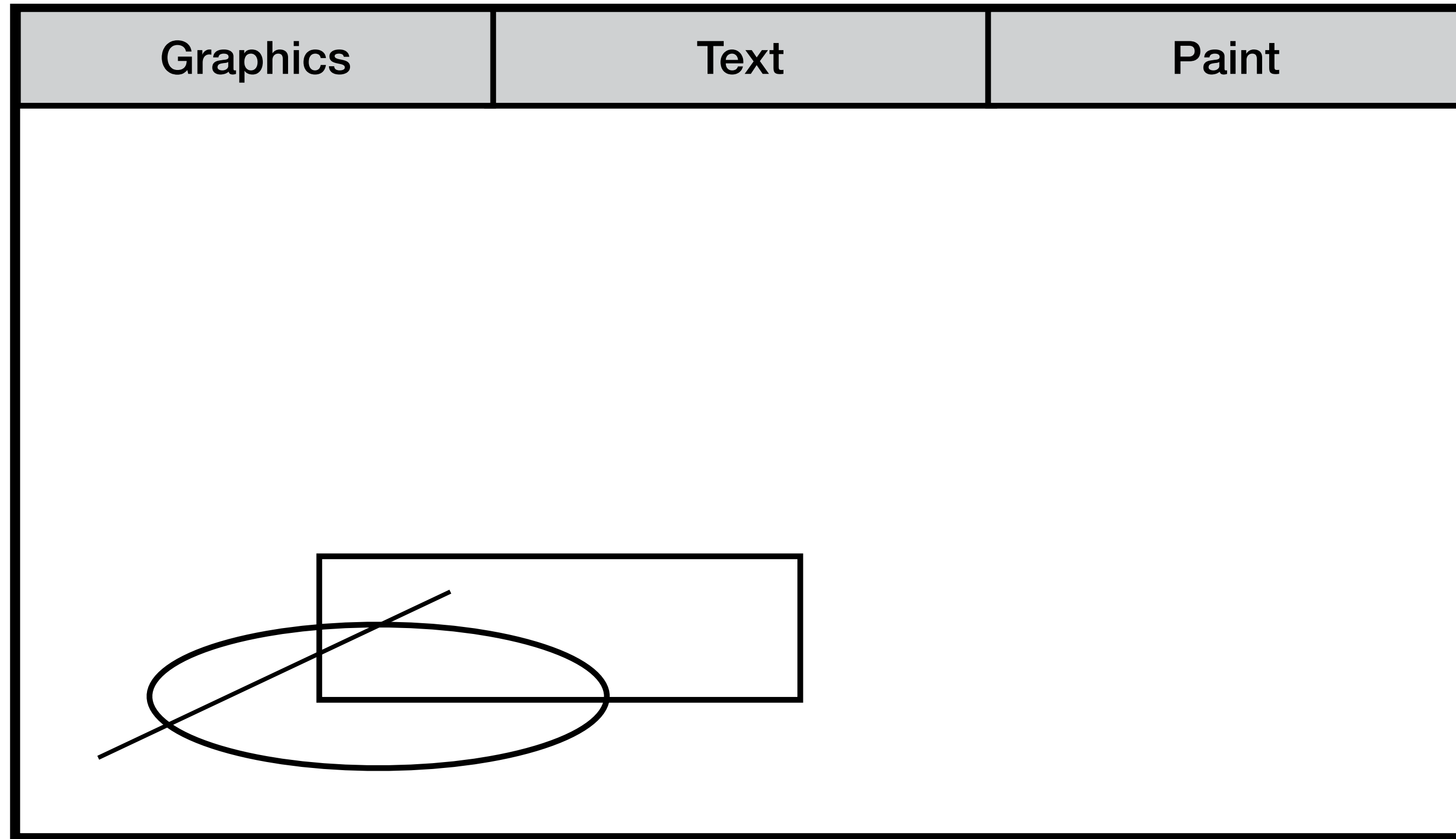

Current state:

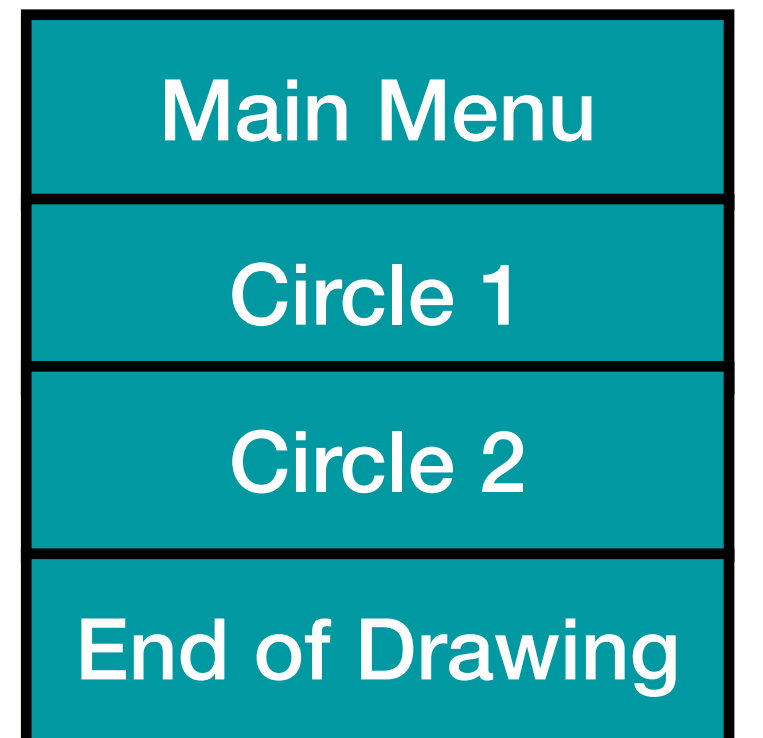

Checking STN Properties: States

- Completeness
 - Can you get anywhere from anywhere?
 - Are all possible actions covered in every state?
 - How easily?
- Reversibility
 - Can you get to the previous state?
 - But NOT undo
- Dangerous states
 - Some states you don't want to get to



Checking Transition Properties: Completeness

- Missing arcs indicate unspecified user input
- What happens when the user double-clicks in the Circle 2 state?

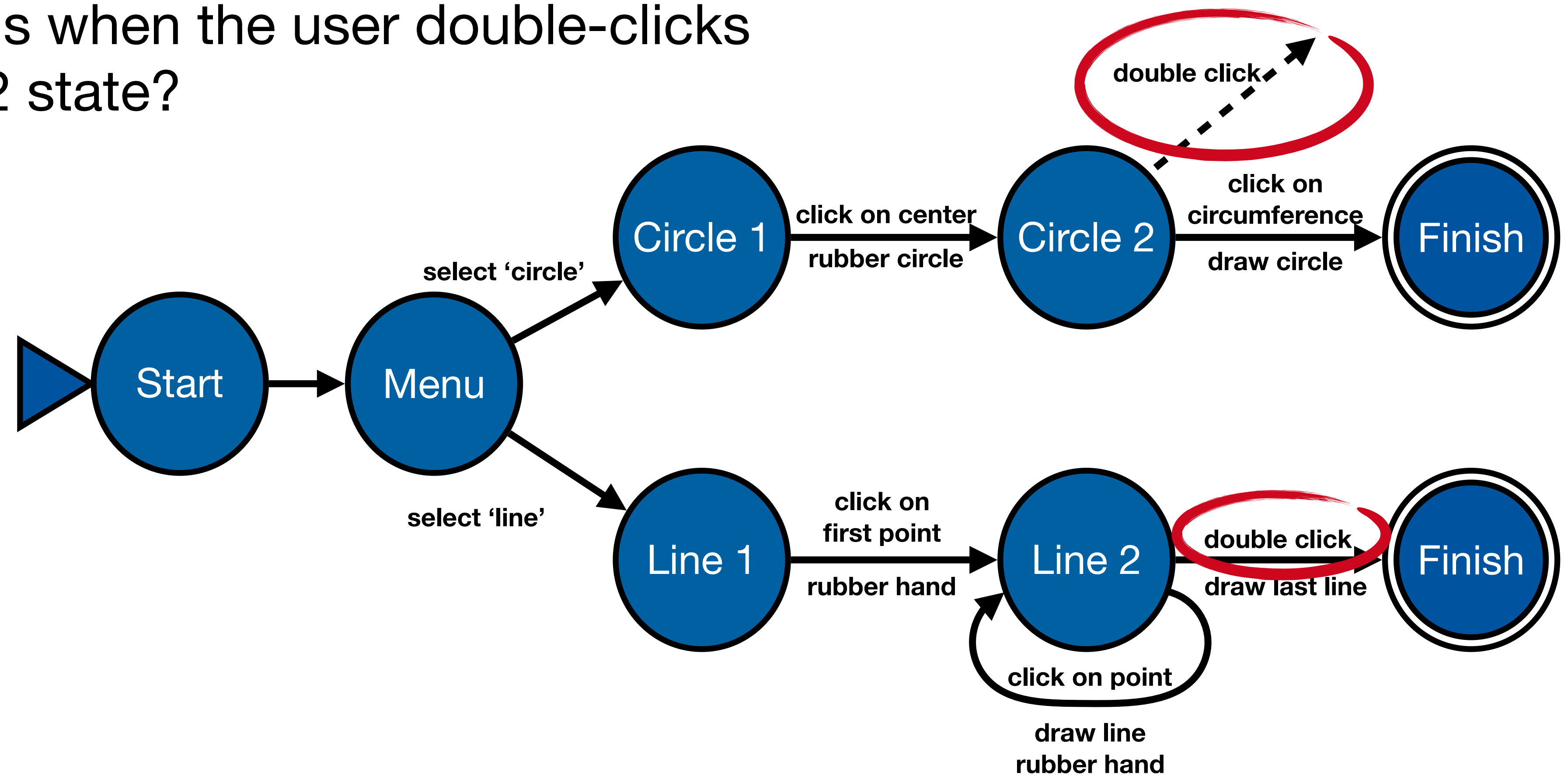

Checking Transition Properties: Reversibility

- E.g., reversing **select 'line'** requires *Click - double click - select 'graphics'* (3 actions)
- Note: Reverse means just getting back to a state, **not** to “undo” its effect

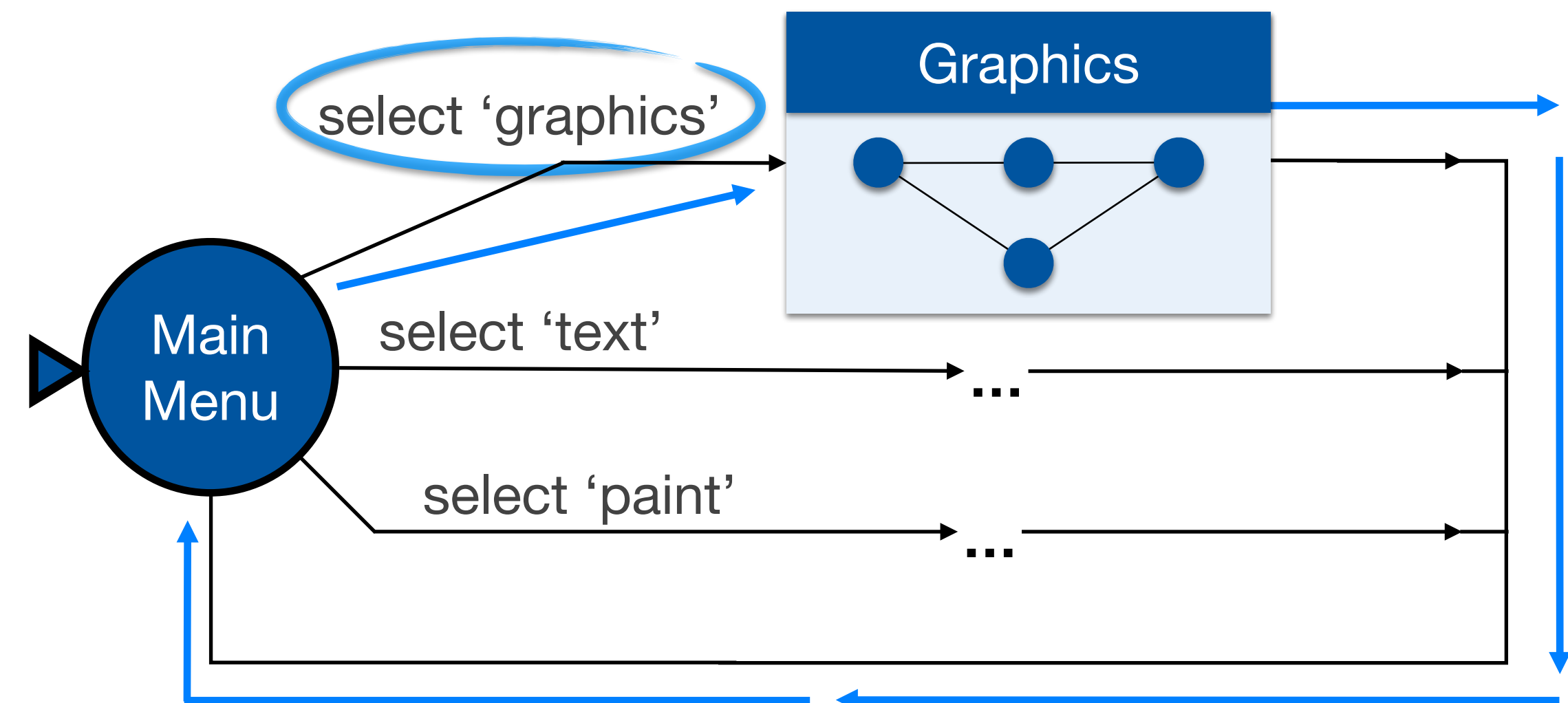
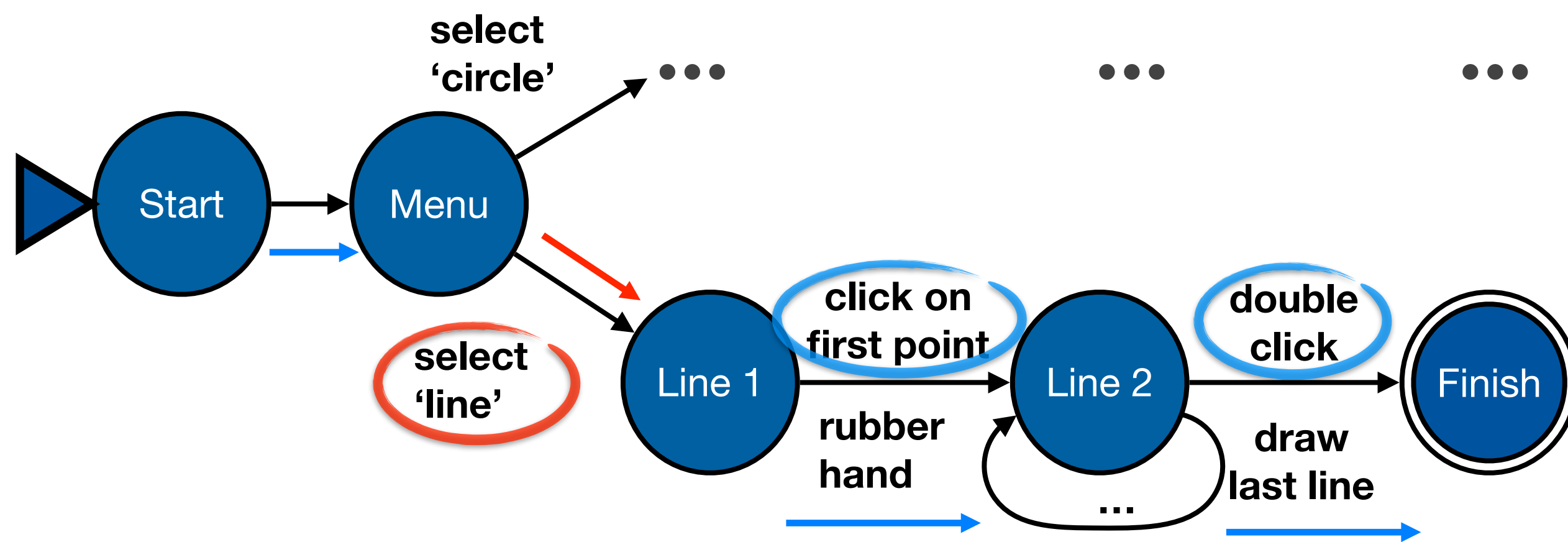

Dangerous States Example

- Word processor: two modes and exit
 - F1 - changes mode
 - F2 - exit (and save)
 - Esc - no mode change
- But ... Esc resets autosave

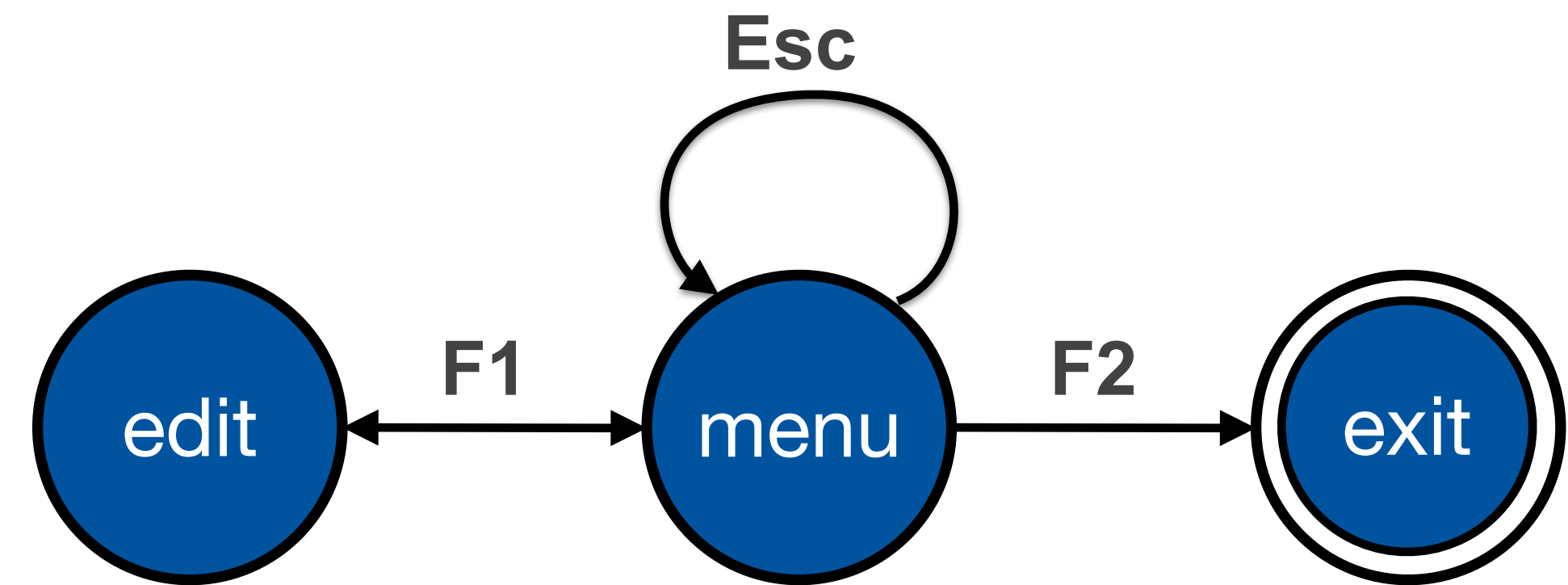

Dangerous States Example

- Exit with/without save \Rightarrow dangerous states
- Duplicate states - semantic distinction

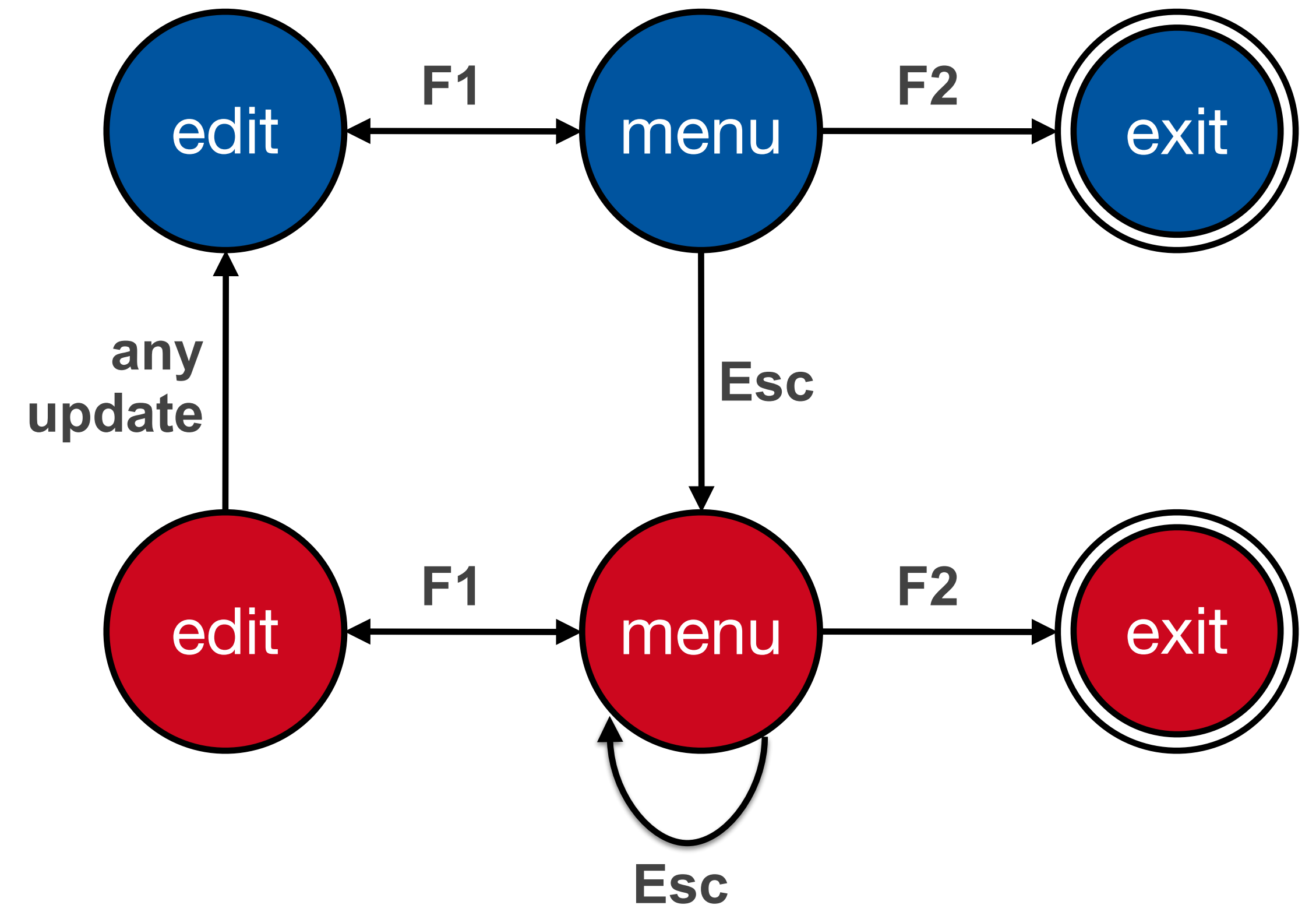

- F1-F2 - exit with save
- F1-Esc-F2 - exit with no save

Dangerous States Example: Layout Matters

Old keyboard—OK

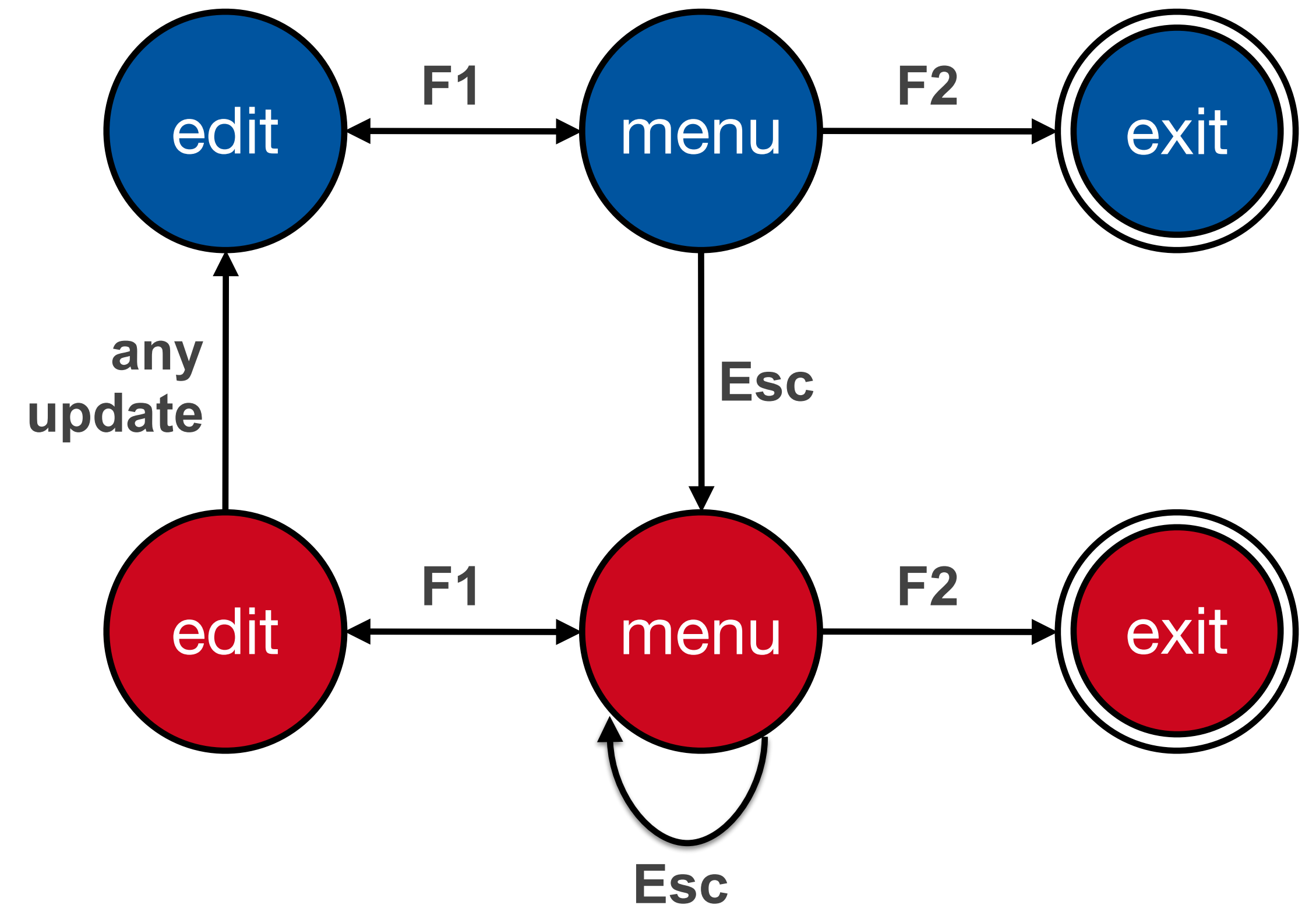
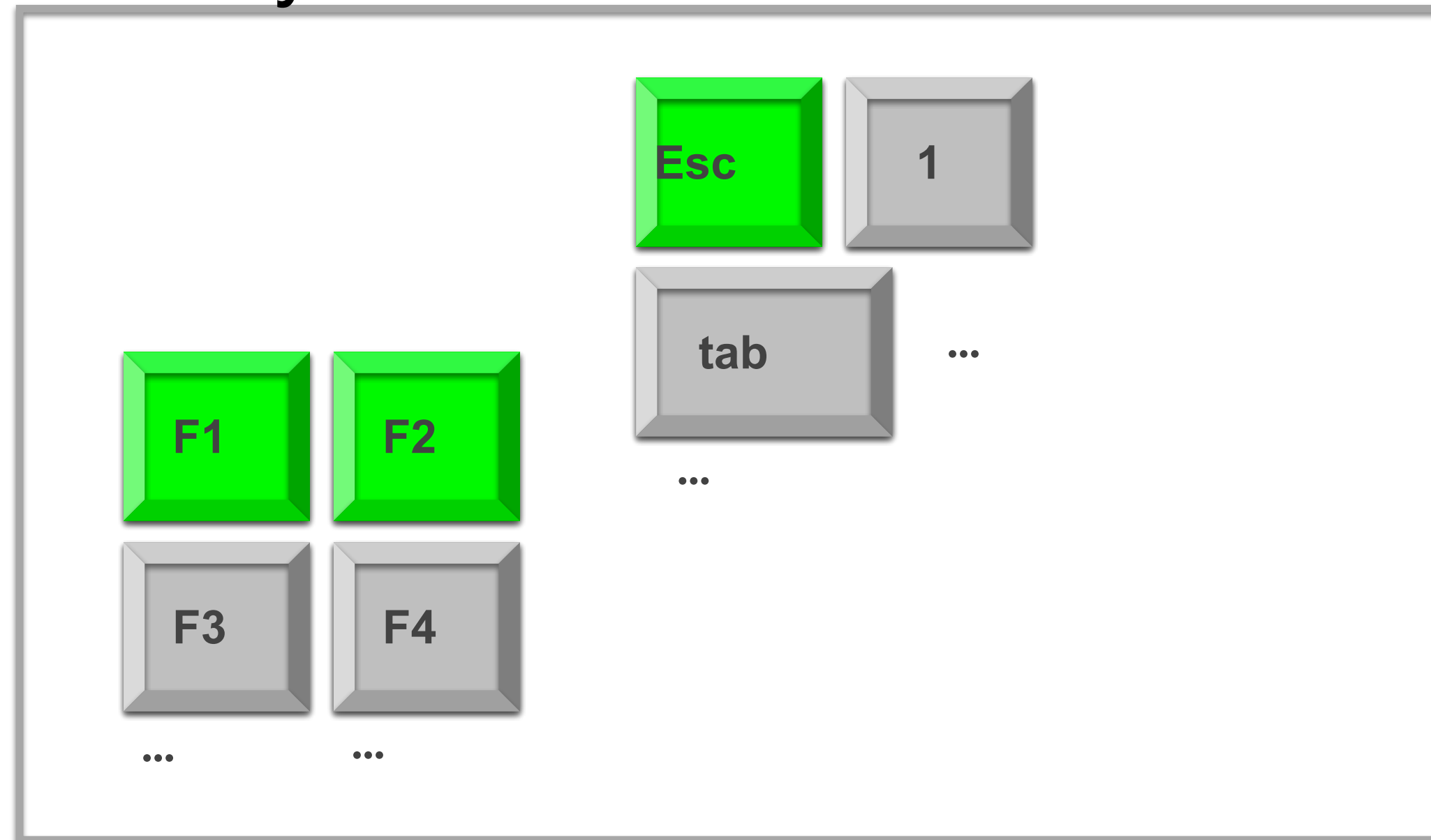

Dangerous States Example: Layout Matters

new keyboard layout

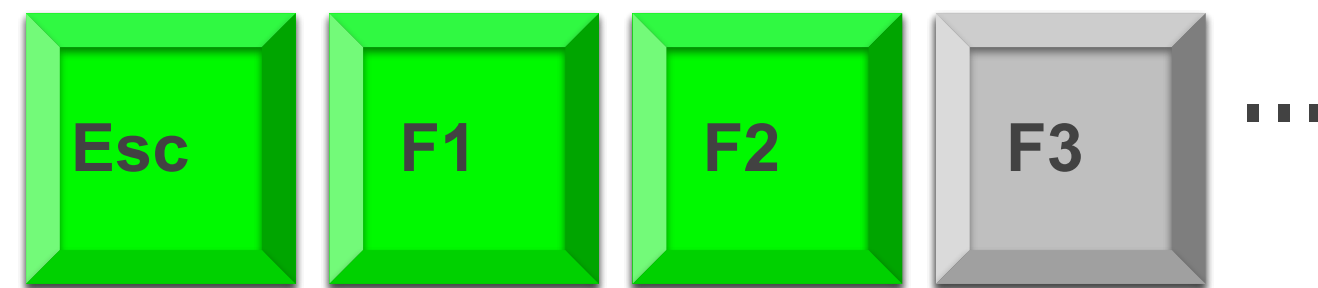

Intend $F1 \rightarrow F2$ (save)

Finger catches Esc

$F1 \rightarrow Esc \rightarrow F2$ — disaster!

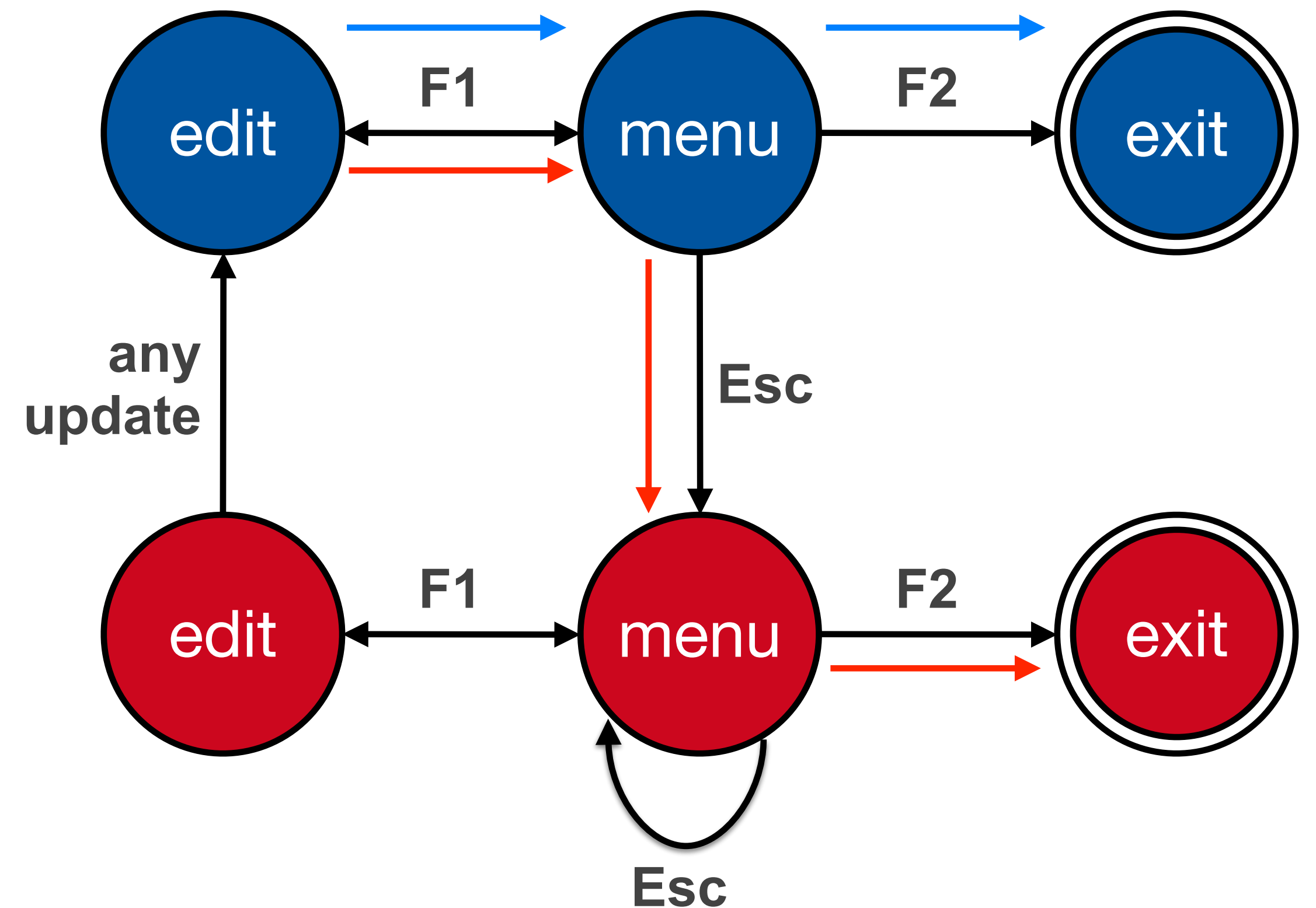

Checking STN Properties: Other Transition Properties

- Determinism
 - Several arcs for one action
 - Deliberate: application decides
 - Accidental: production rules
- Nested escapes
- Consistency
 - Same action, same effect?
 - Modes and visibility

In-Class Exercise: STN



- Simple dialog to select bold, italics, and/or underline
- Draw the state diagram for:
 - Only Bold checkbox
 - Bold and italics checkboxes
 - All three checkboxes

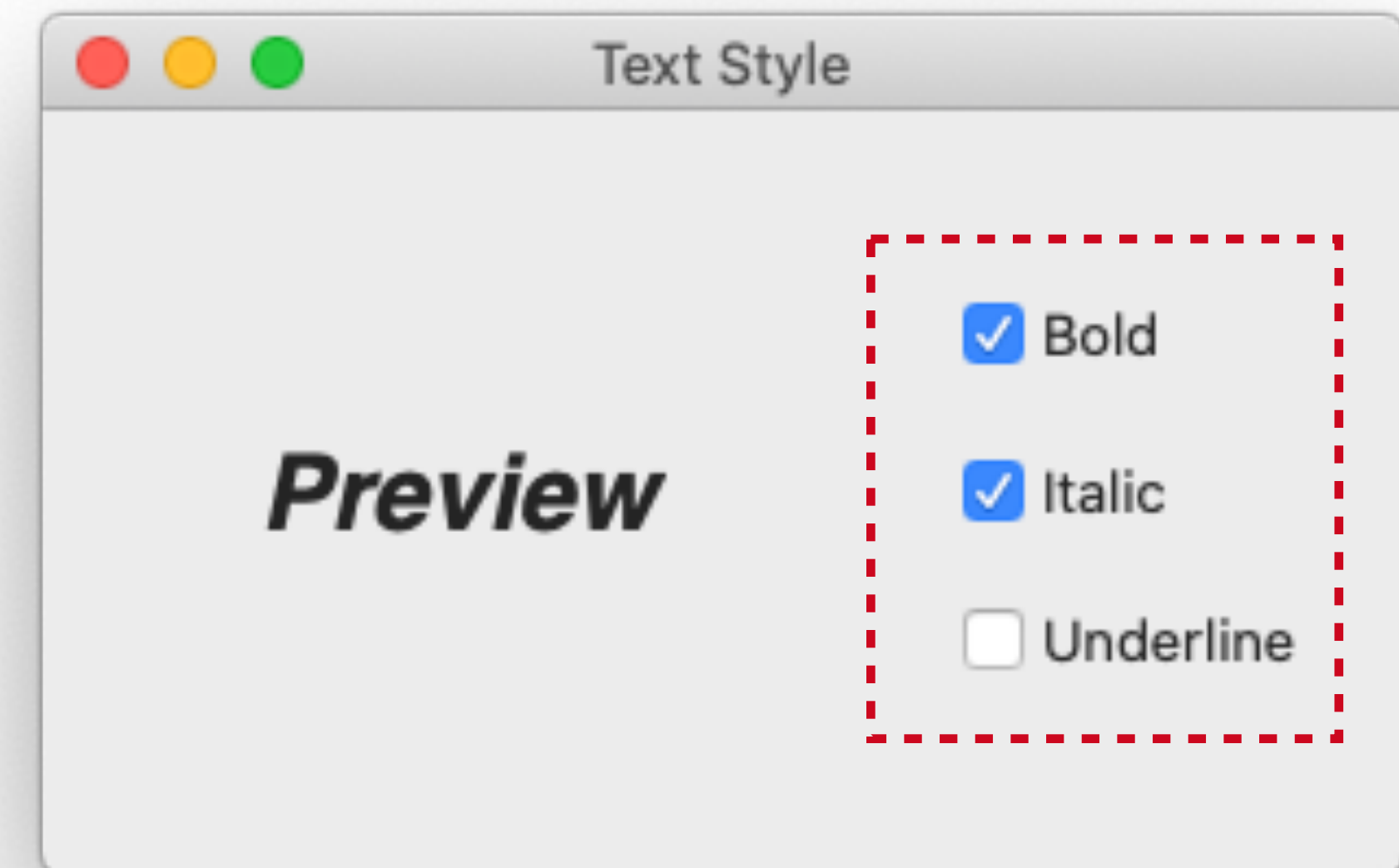

Bold Checkbox

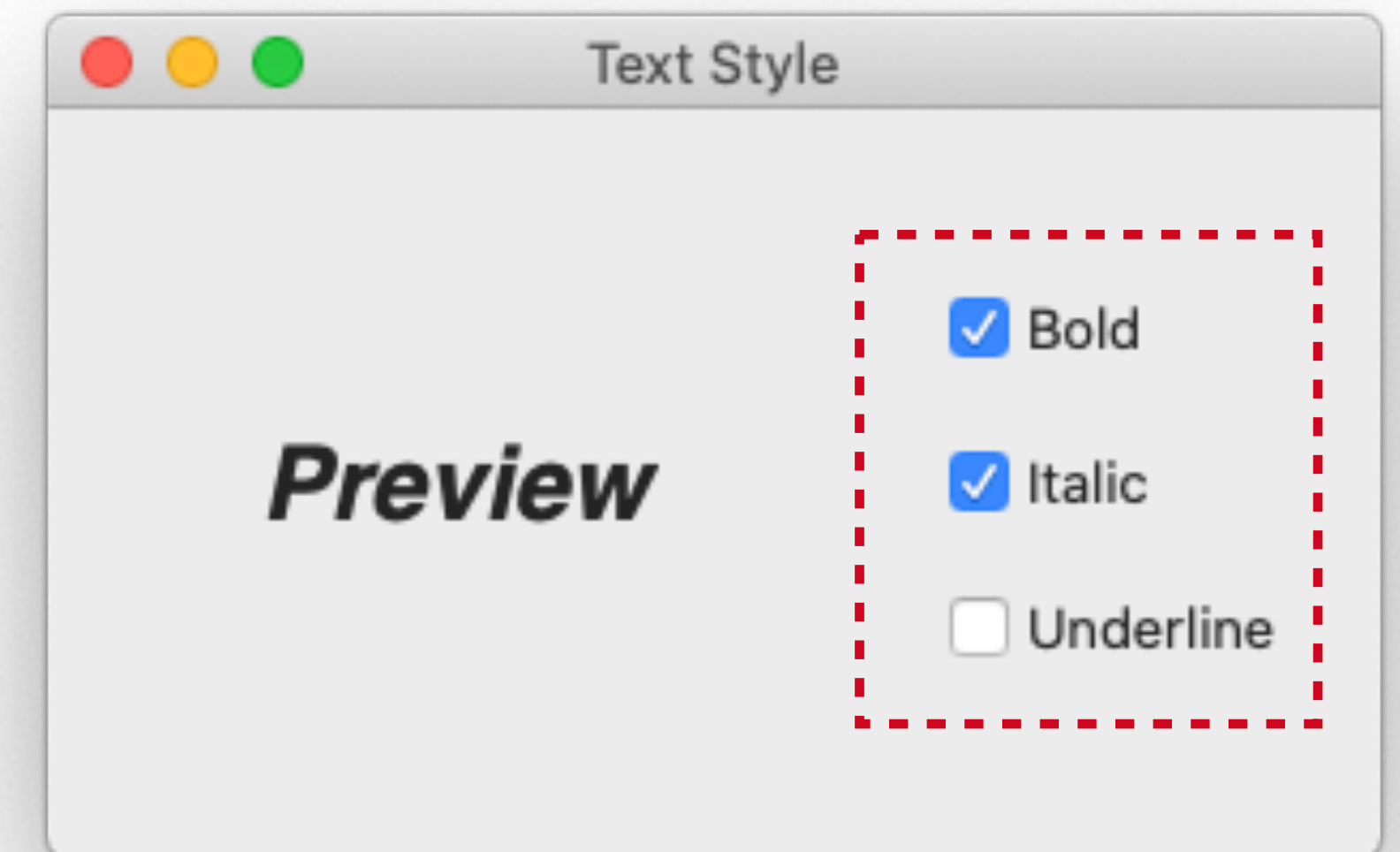
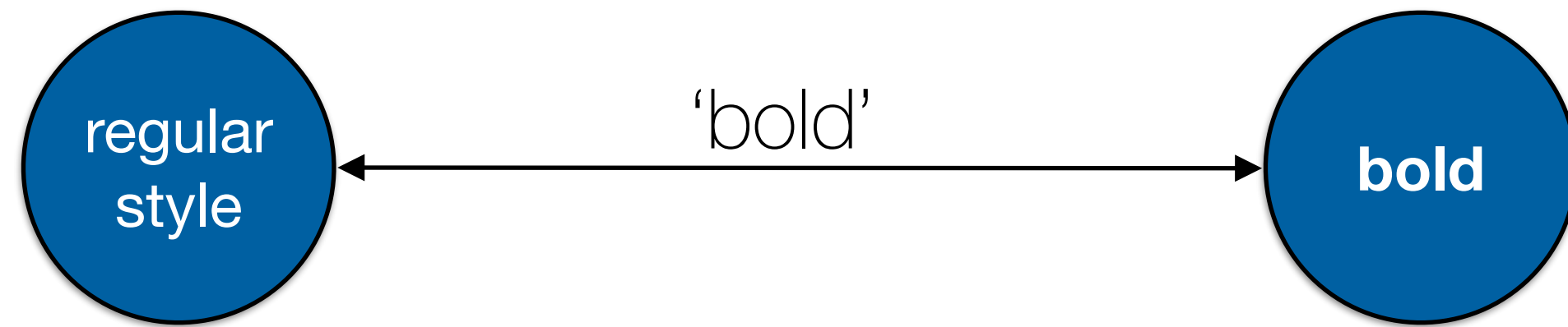

Bold & Italic Combined

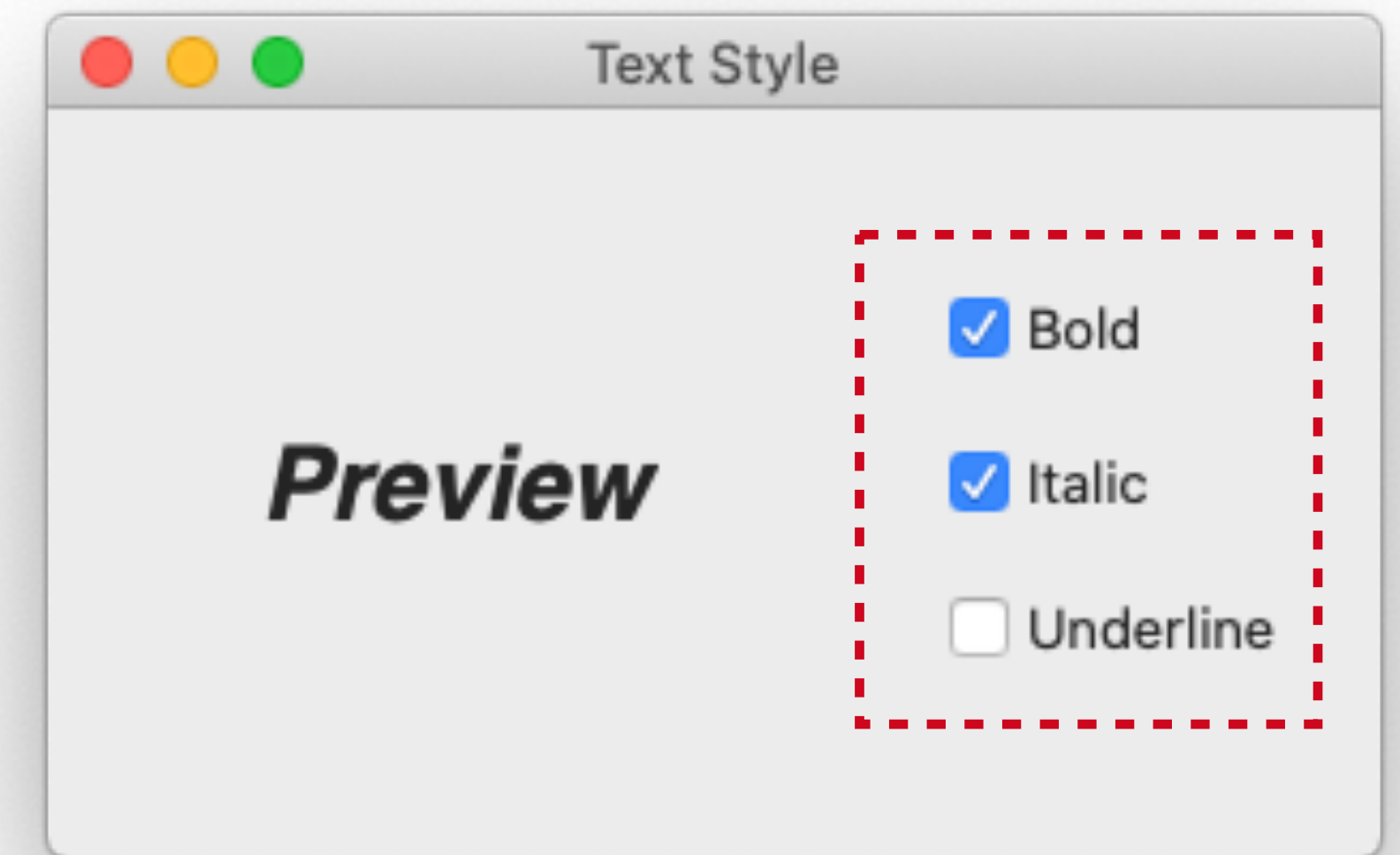
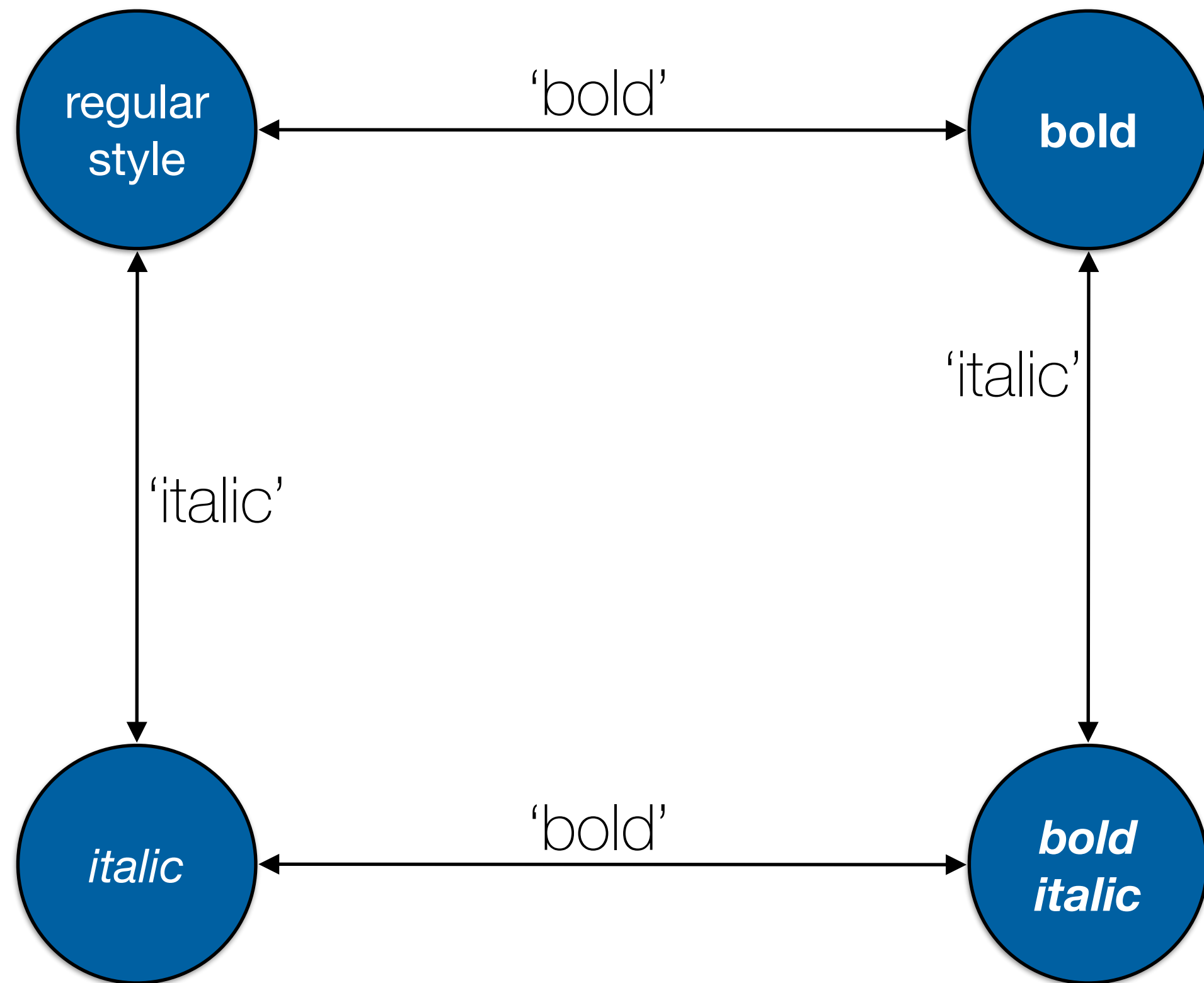

All Three Options

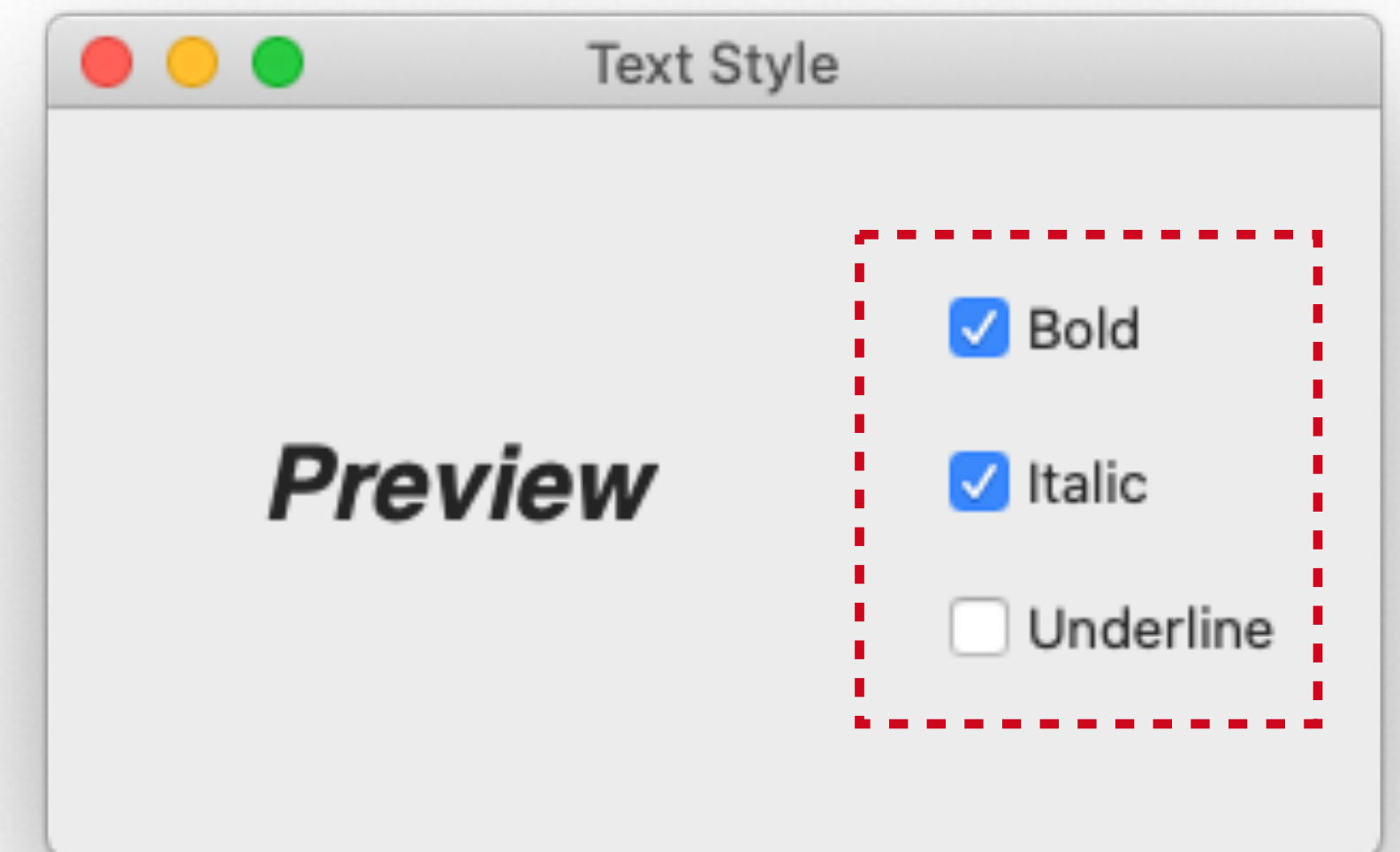
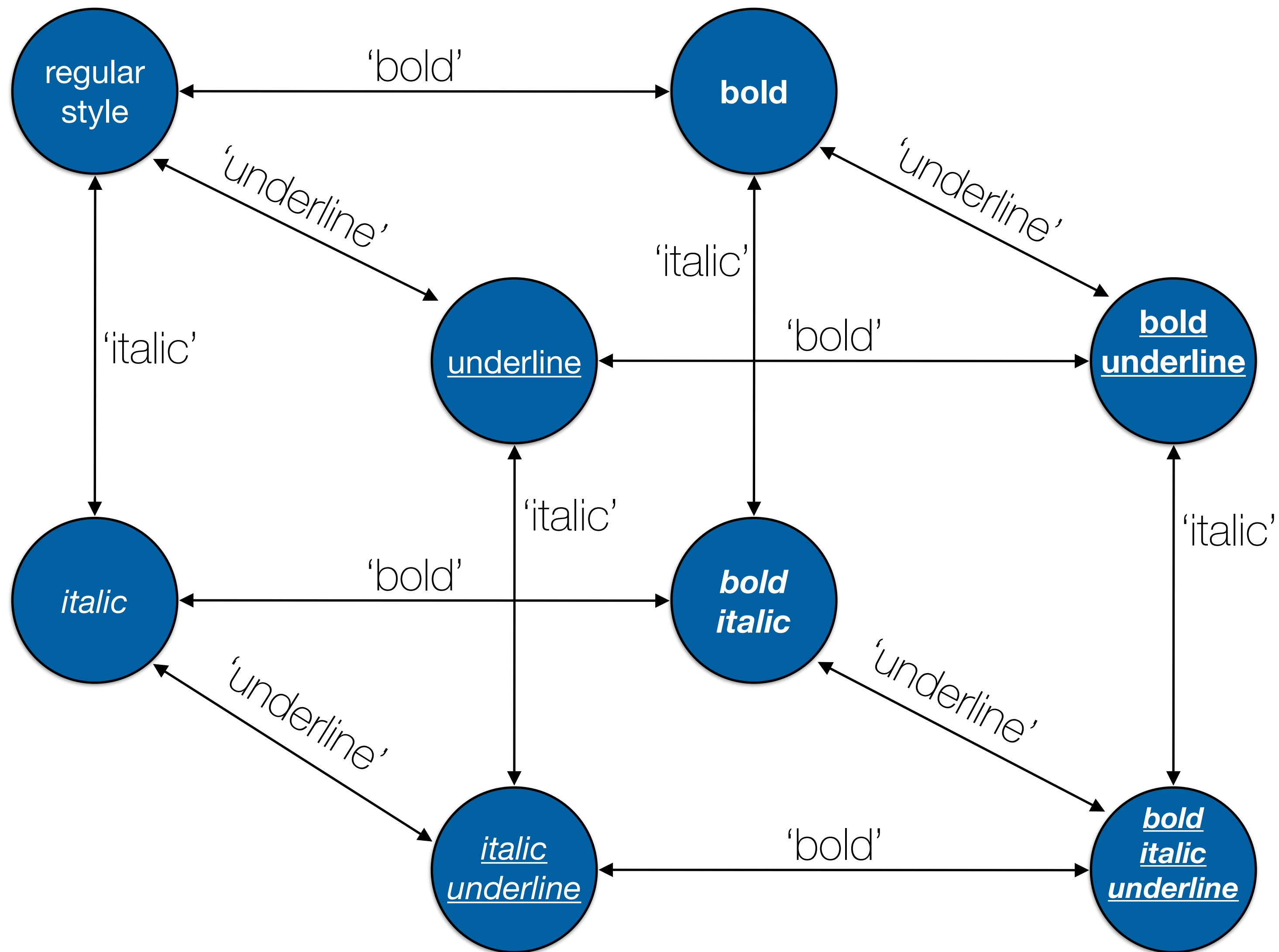

Adding Another Option...

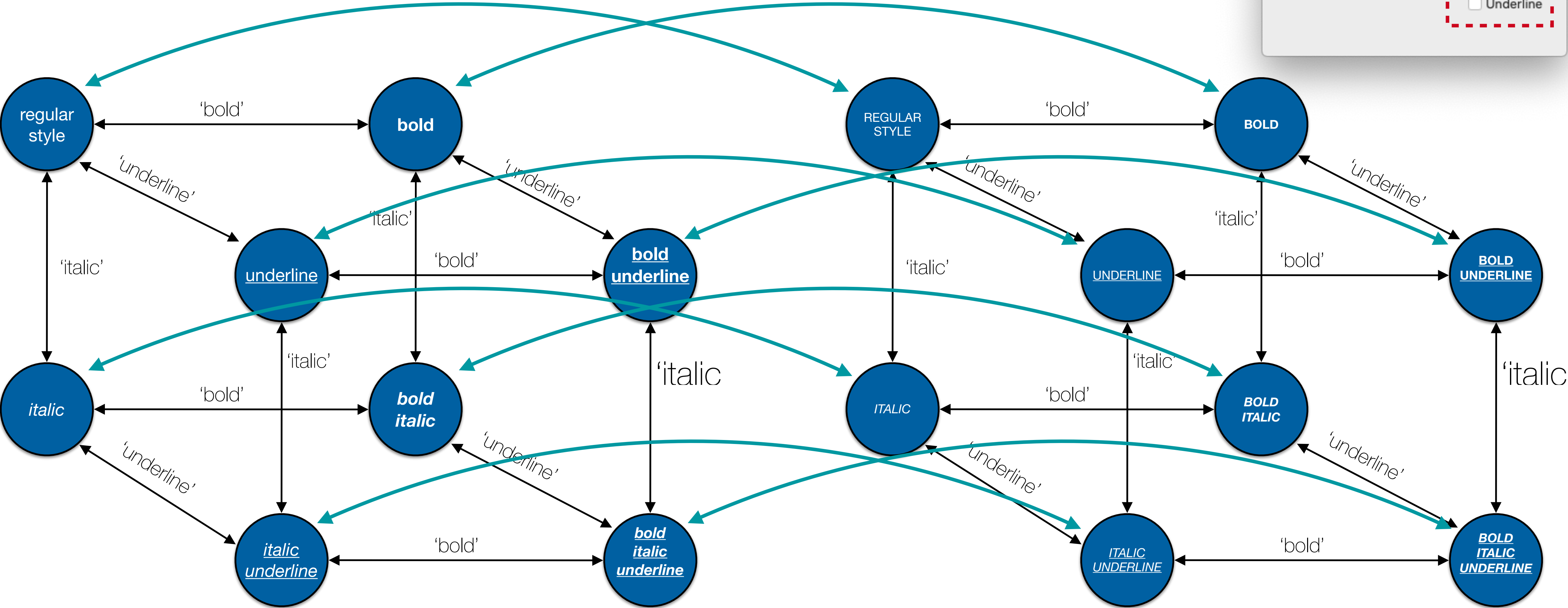
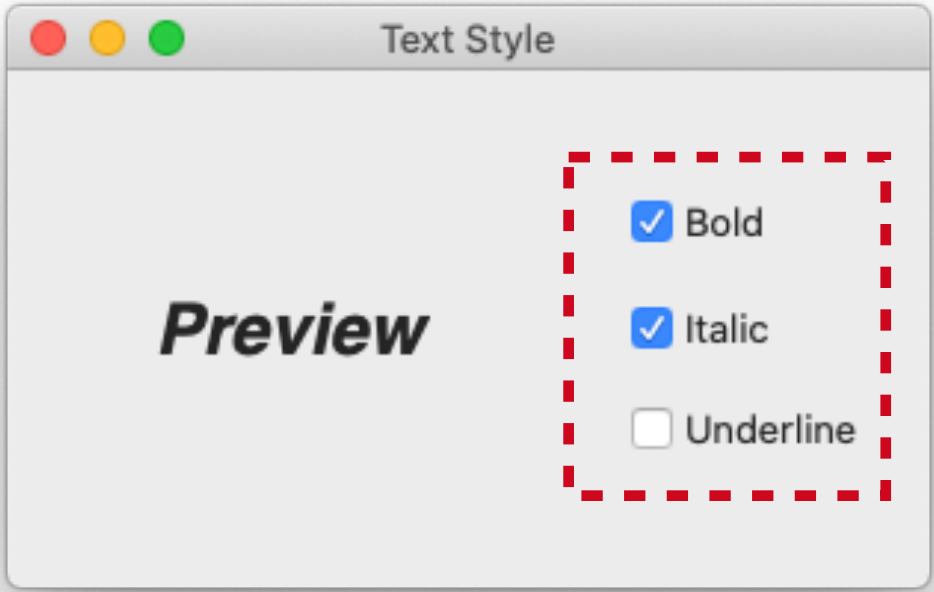

Normal case

CAPITALIZED

STNs: State Explosion

- Problem: Combining two concurrent STNs with N and M states leads to new STN with $N \times M$ states
- STN hides clear structure of the dialog
- Especially problematic with modern GUIs
- Similar problems with “Escape” and “Help” options
 - ESC can be modeled as special second “Finish” exit active throughout subdialog
 - Help can be modeled as little subdialog hanging off every single state in the STN
 - Gets messy



Example: ESC & Help in STNs

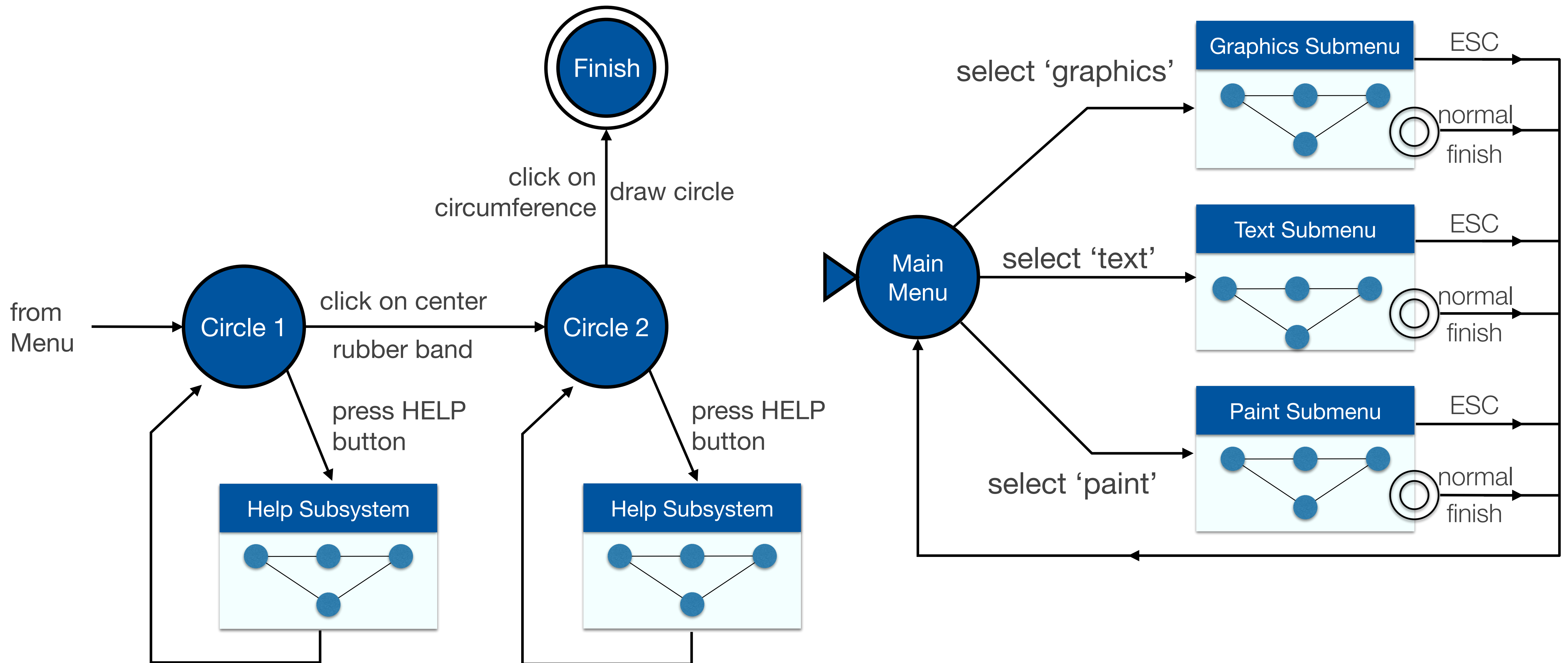

Petri Nets

- Better approach to dialogs that have several states at once
- But not better for sequential dialogs and mutually exclusive UI elements (radio buttons)
- Relatively old formalism to model concurrency



Petri Nets

- Transition fires when all input places have one or more token
 - A token is produced in each output place
- Positions of all tokens represent the current state
 - NOTE: This is different from state machines

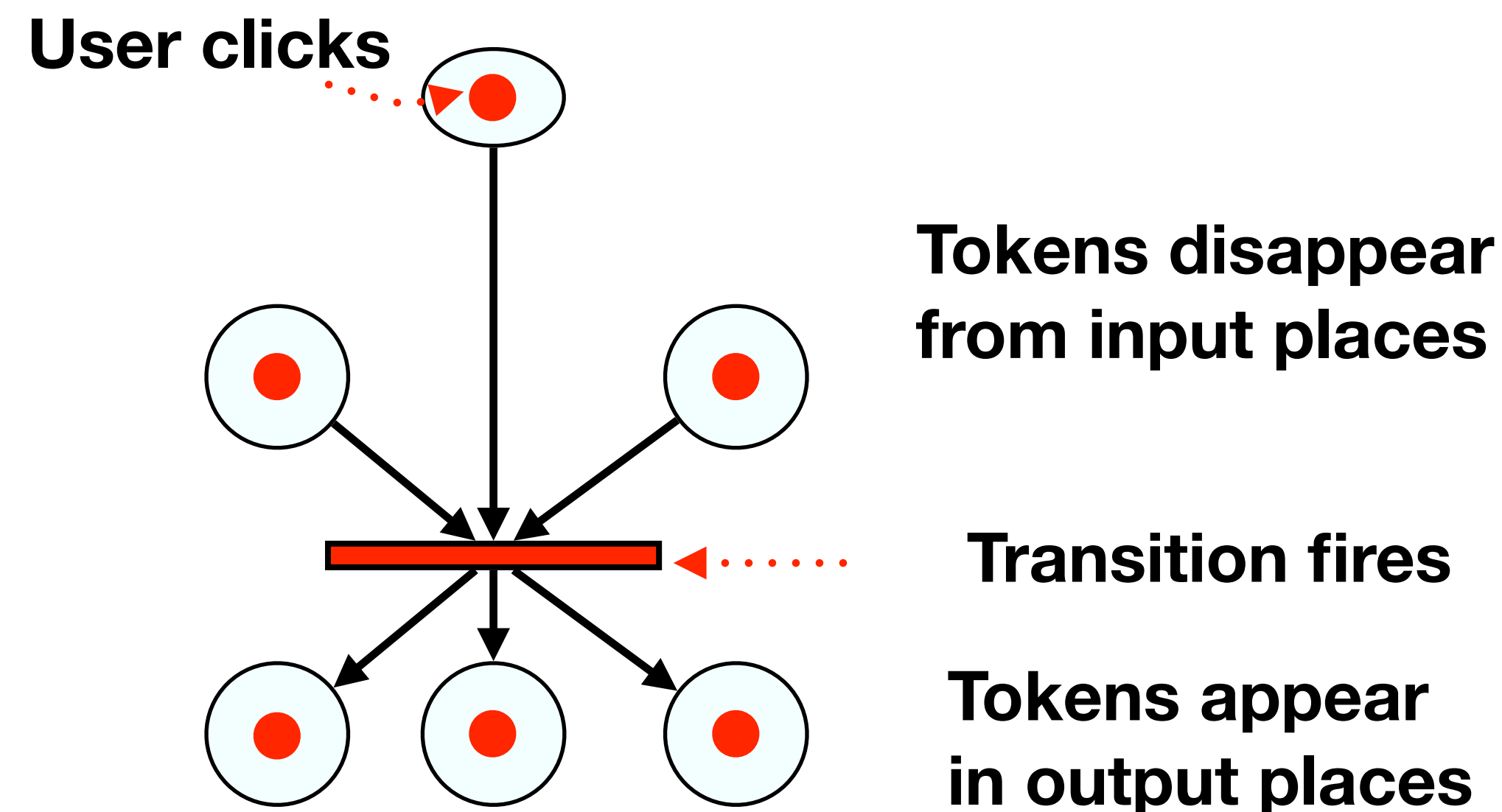
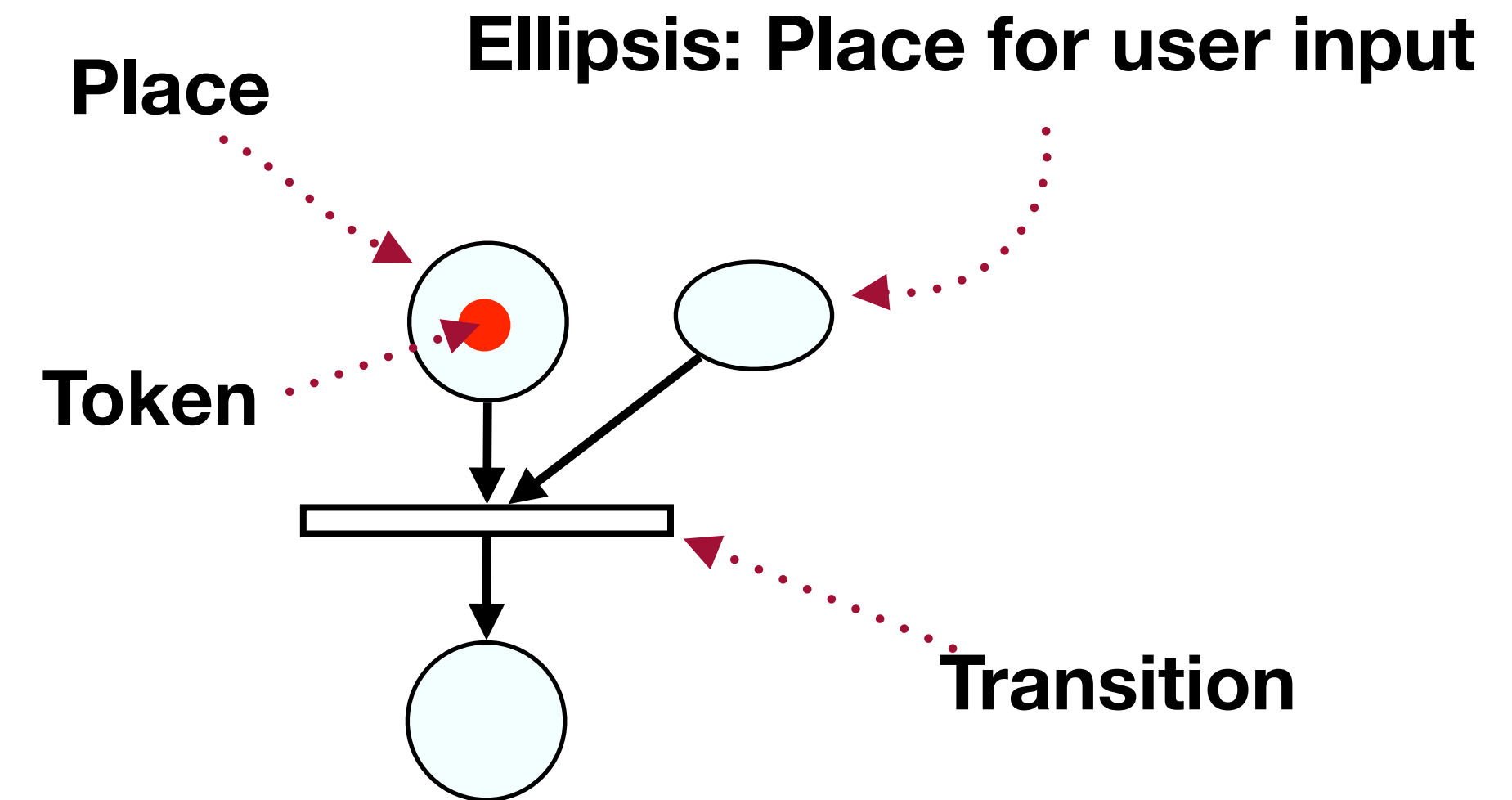

In-Class Exercise



Draw the Petri net for our dialog box with concurrent “Bold” and “Italic” options (ignore “Underline” for now)

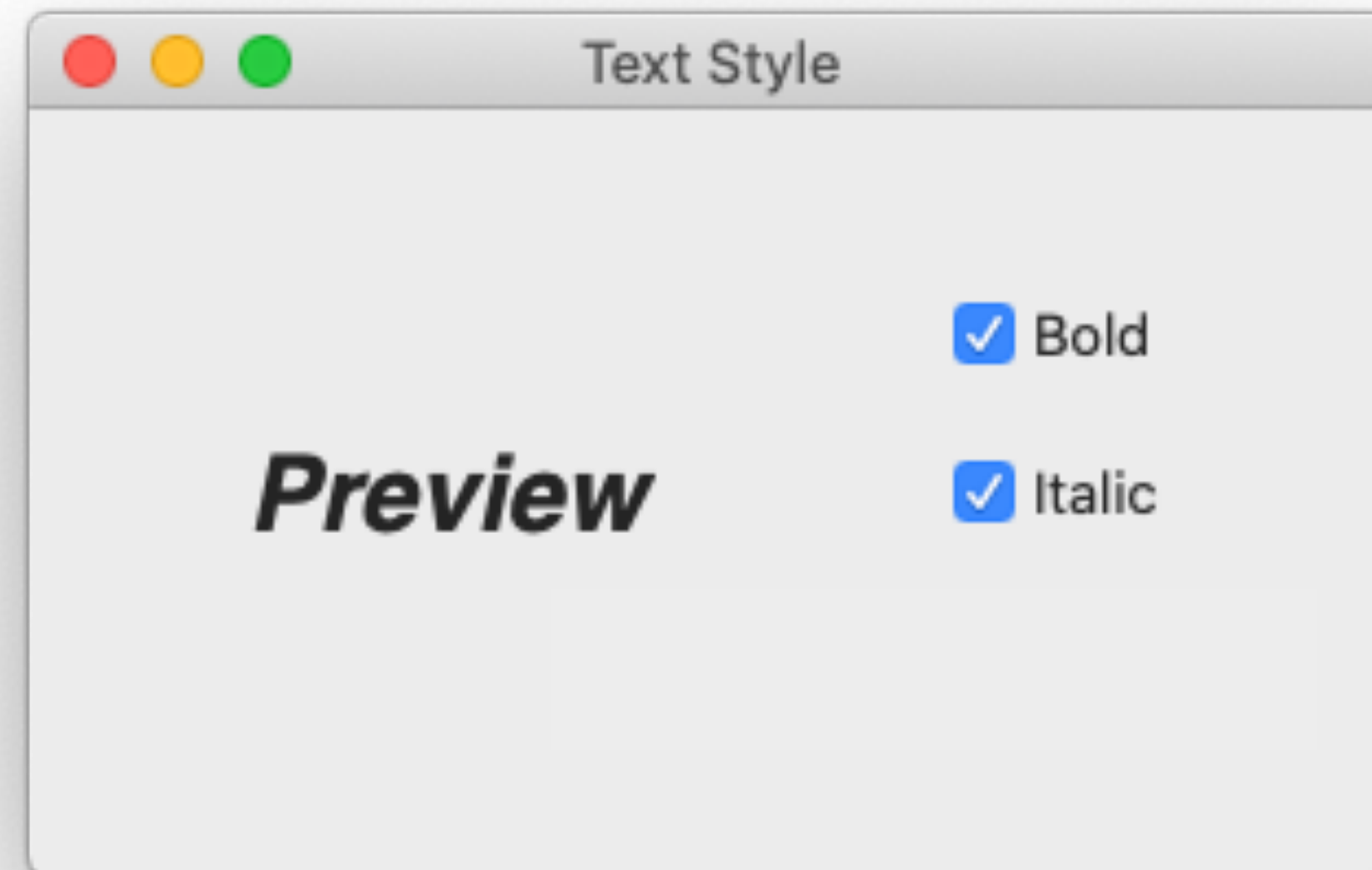

Petri Net For "Bold & Italic" Dialog

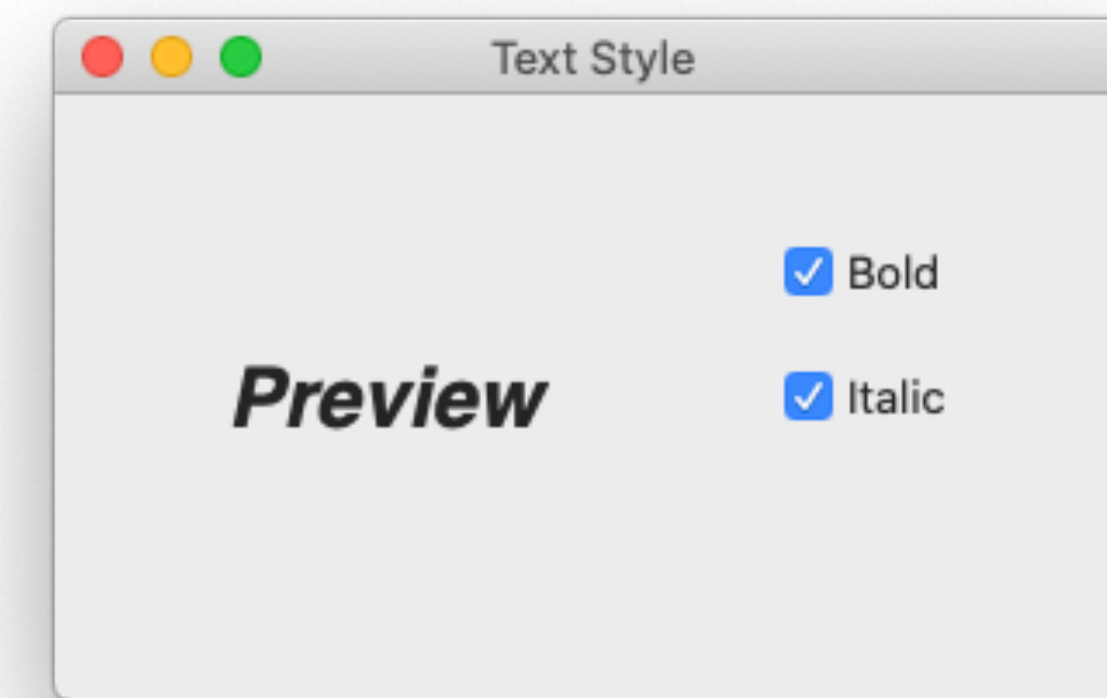

Tokens are consumed from all input places

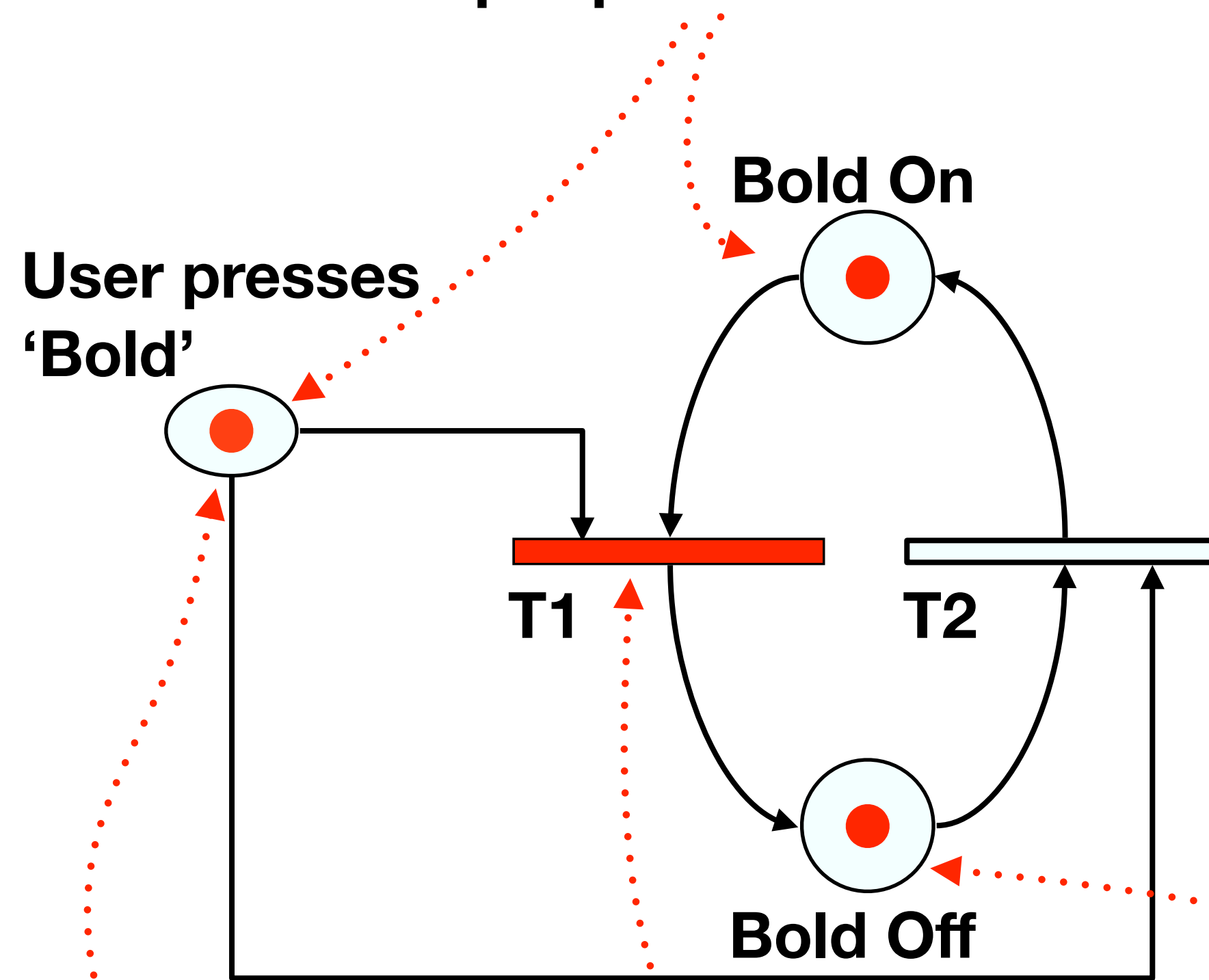

User action represented as a new token

Transition 'fires' when all input places have tokens

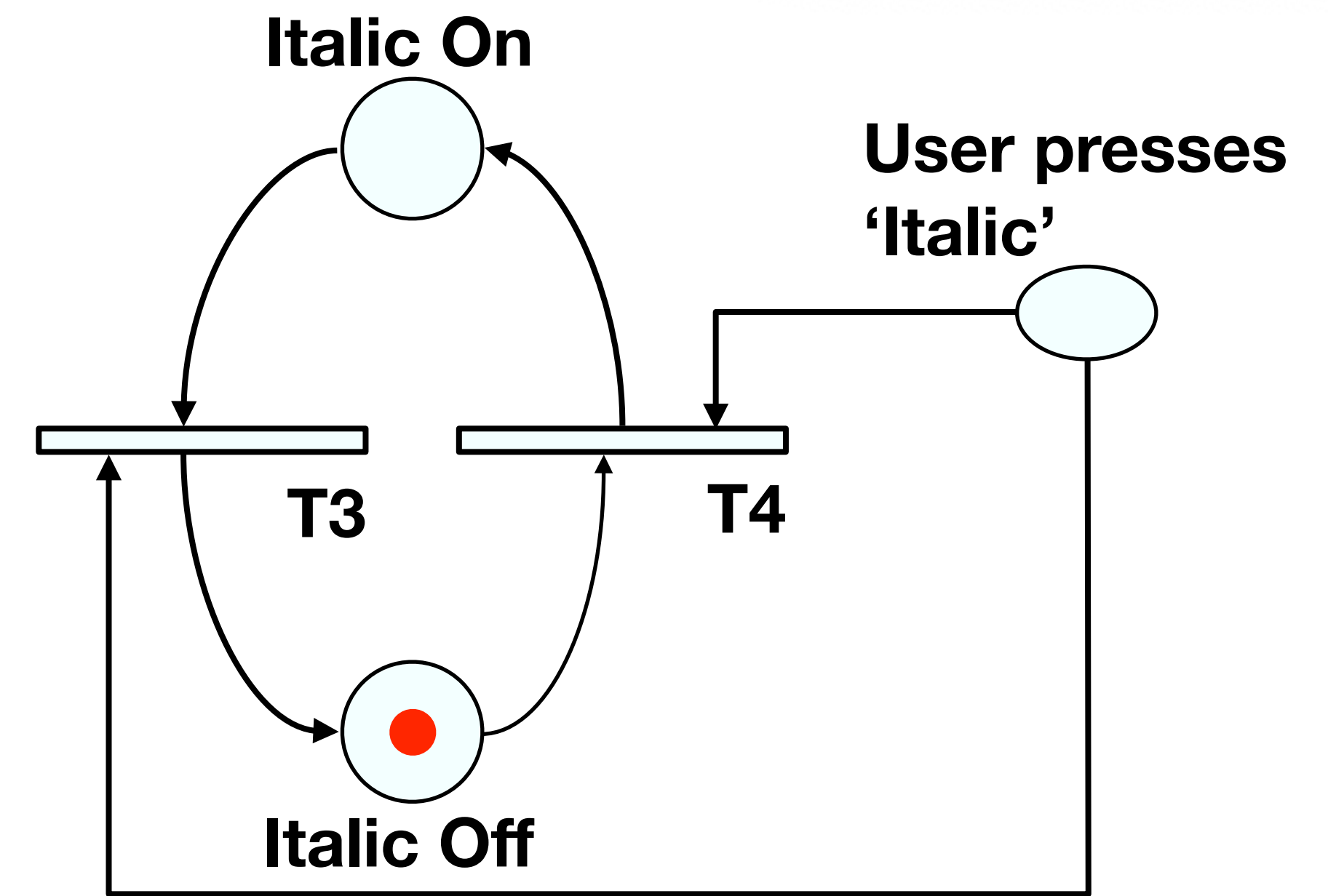

A token is produced in each output place

Petri Net For “Bold & Italic & Underlined” Dialog

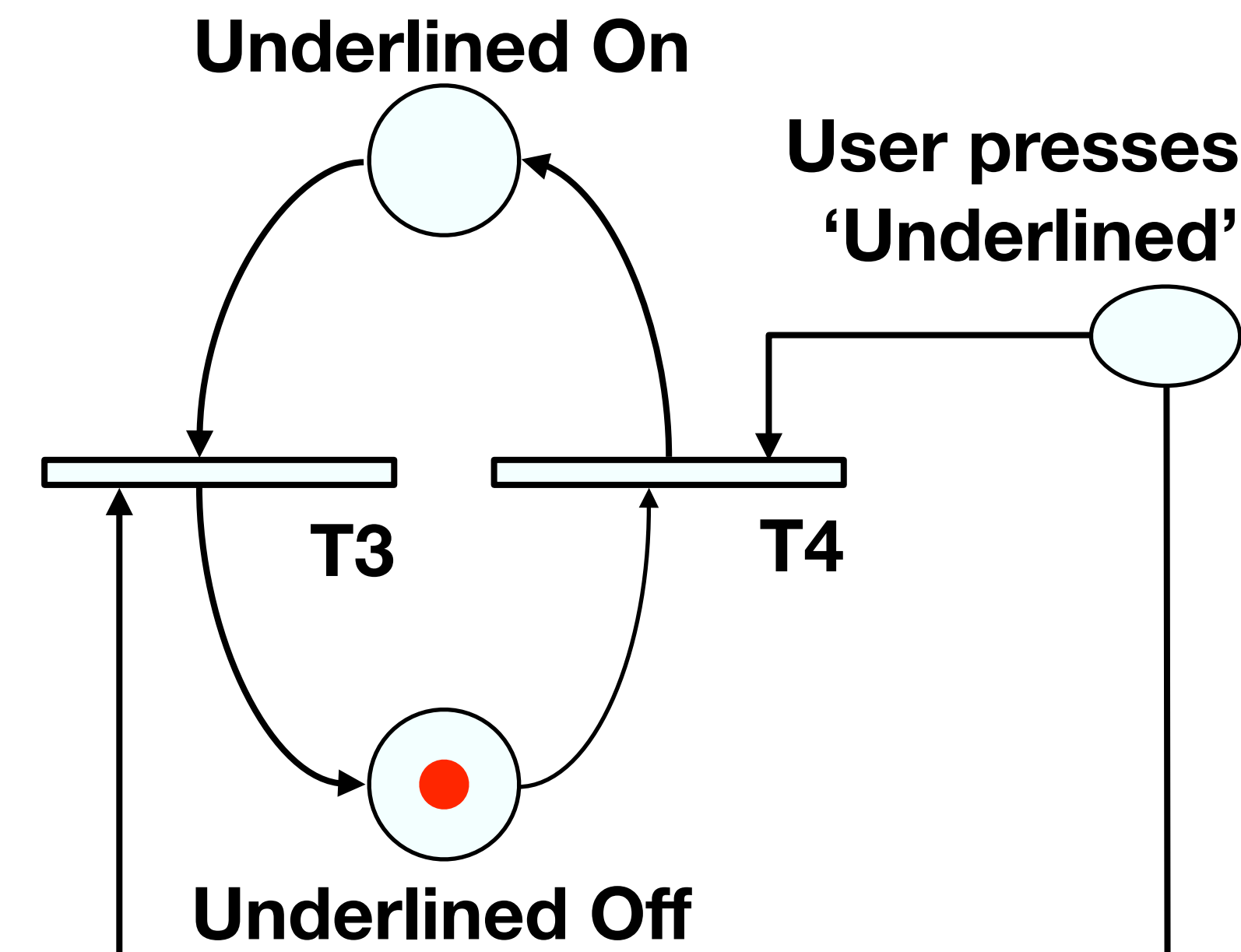
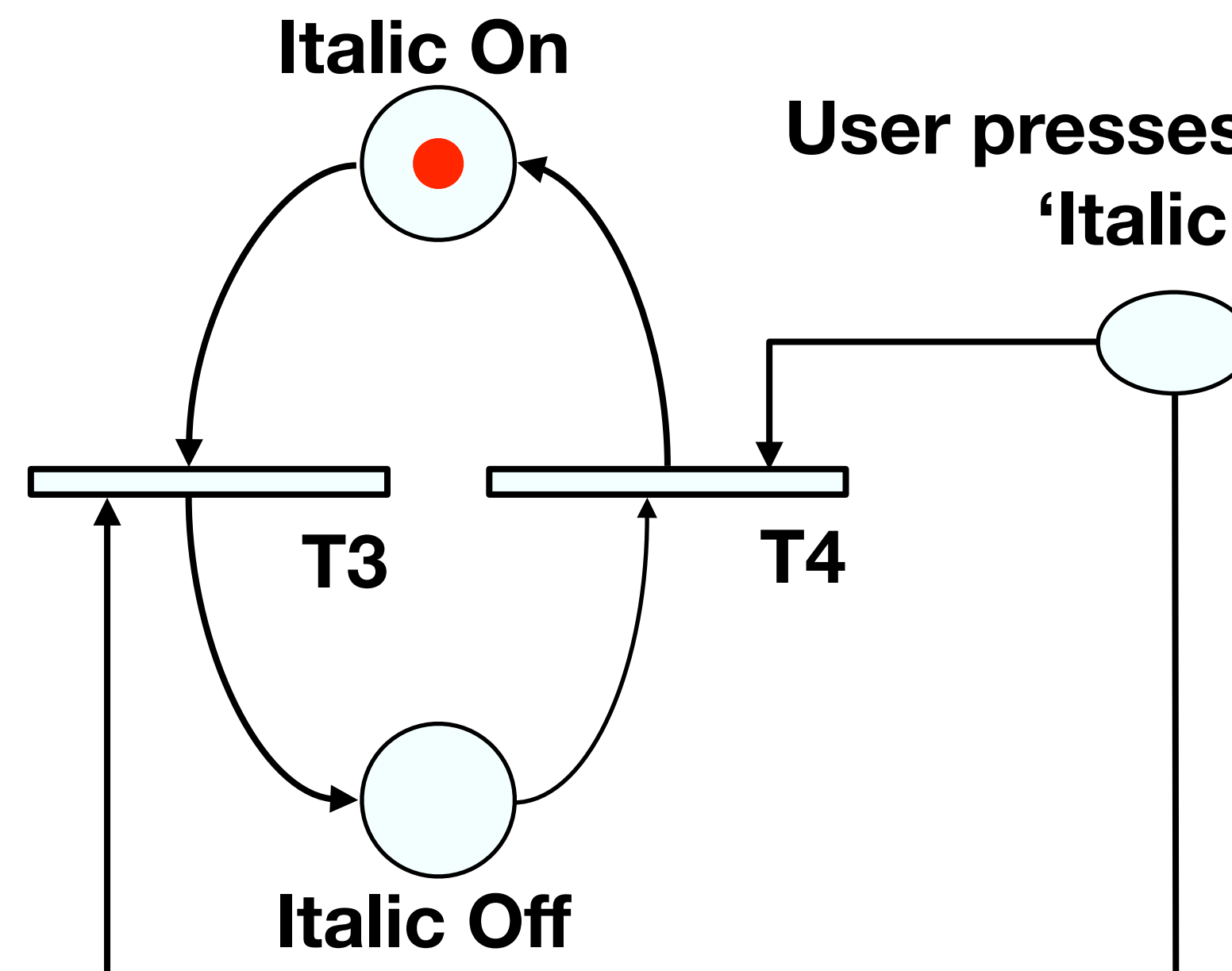
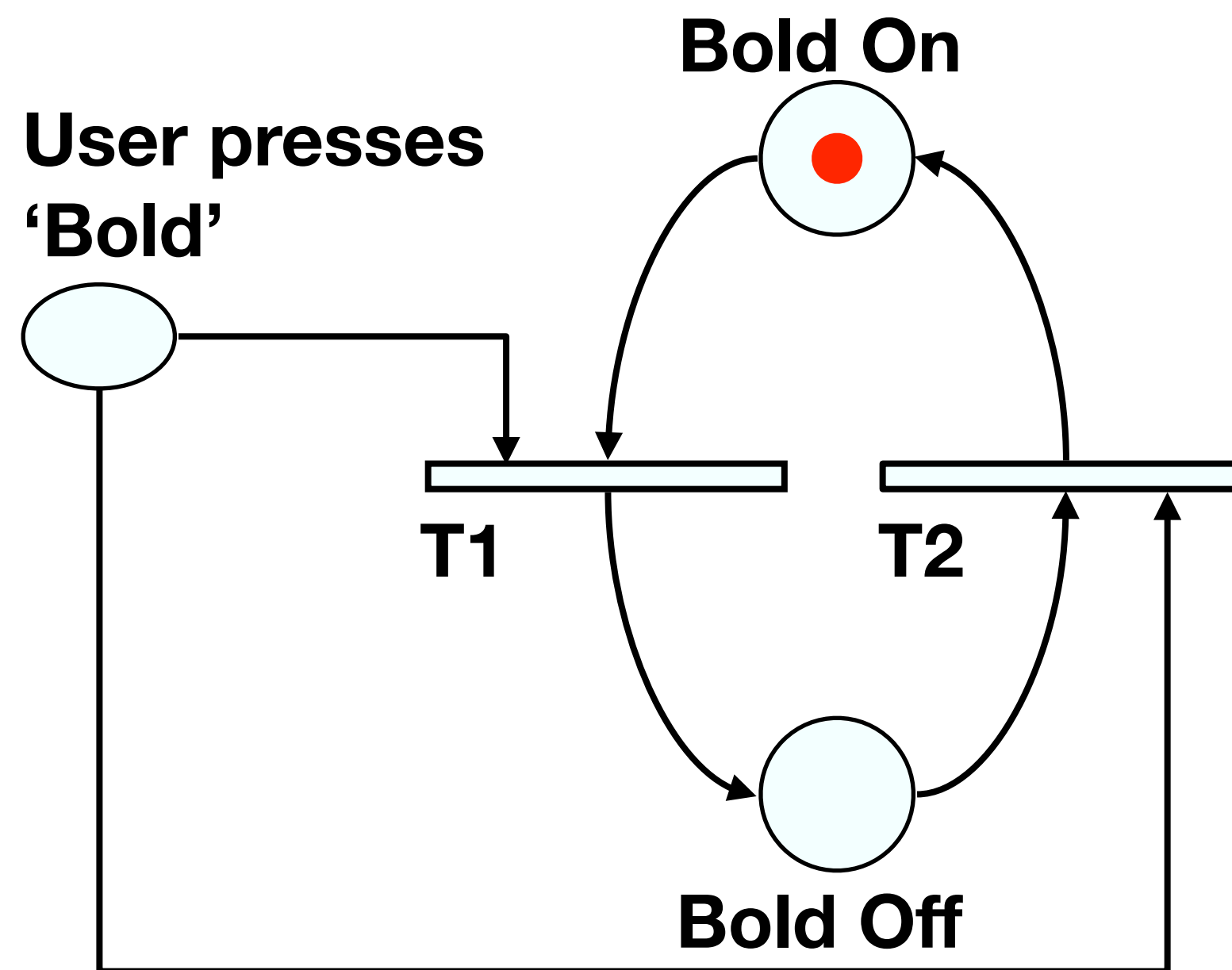
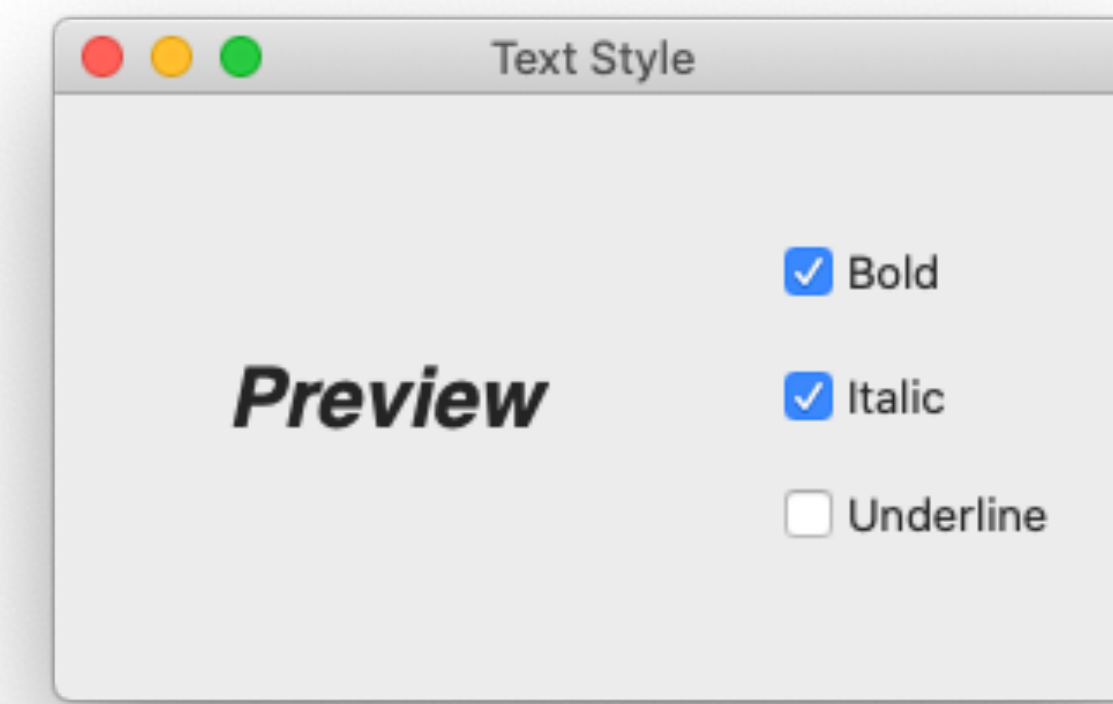

State Charts

- By Harel; used in UML
- Example: TV Control Panel
- State Charts extend STNs
 - Hierarchy
 - Concurrent sub-nets
 - ON resumes both state machines
 - Escapes
 - OFF always active
 - History
 - Link marked “H” goes back to last state on re-entering subdialog

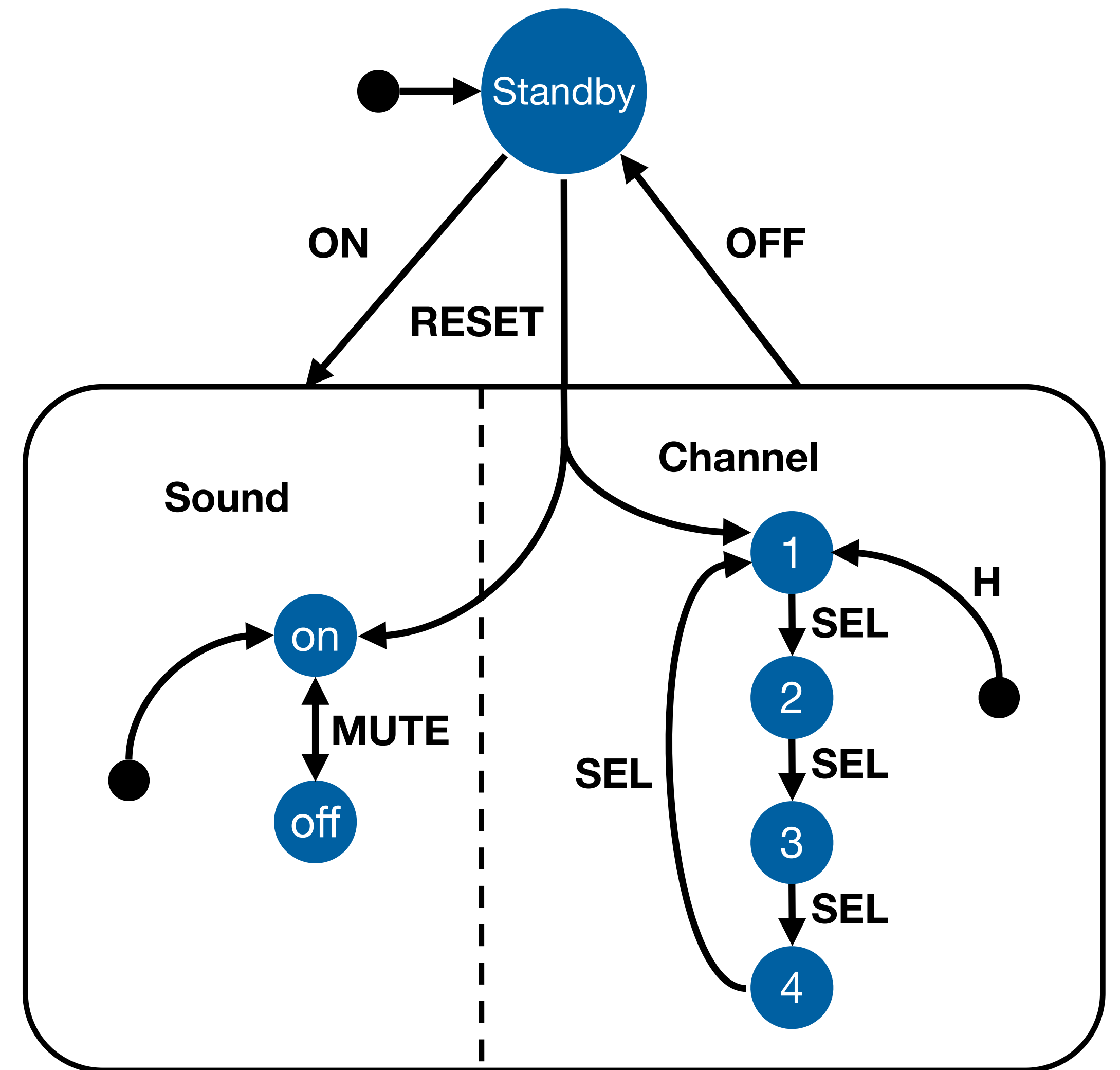

Diagrams For User Documentation

- Some dialog descriptions are clear enough to serve as user documentation (similar to GOMS)
- Especially if description uses screen shots and is semi-formal



Digital Watch – User Instructions

- Two main modes
- Limited interface
 - 3 buttons
- Button A changes mode

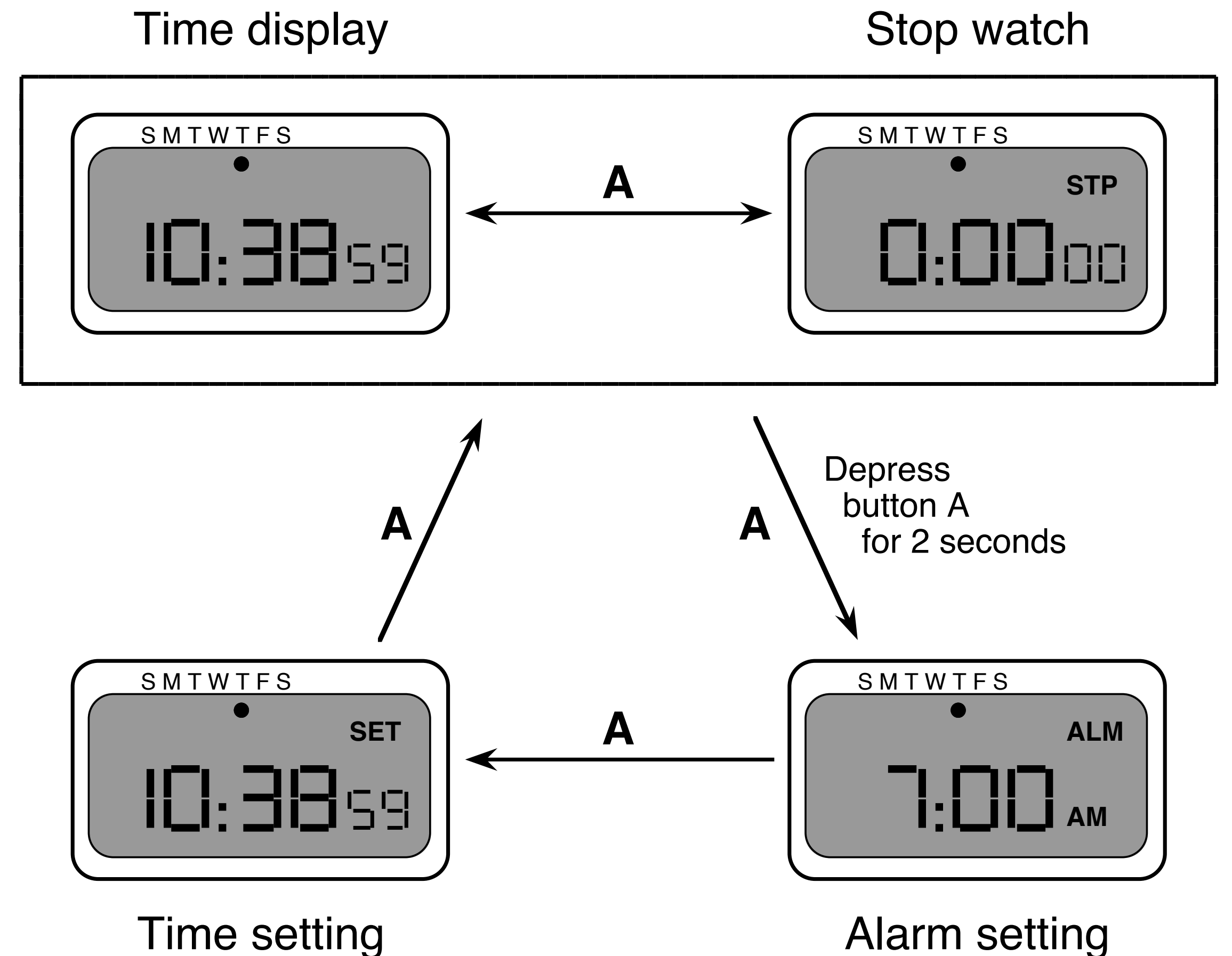

Digital Watch – User Instructions

- Dangerous states
- Completeness
 - Distinguish depress A and release A
 - What do they do in all modes?

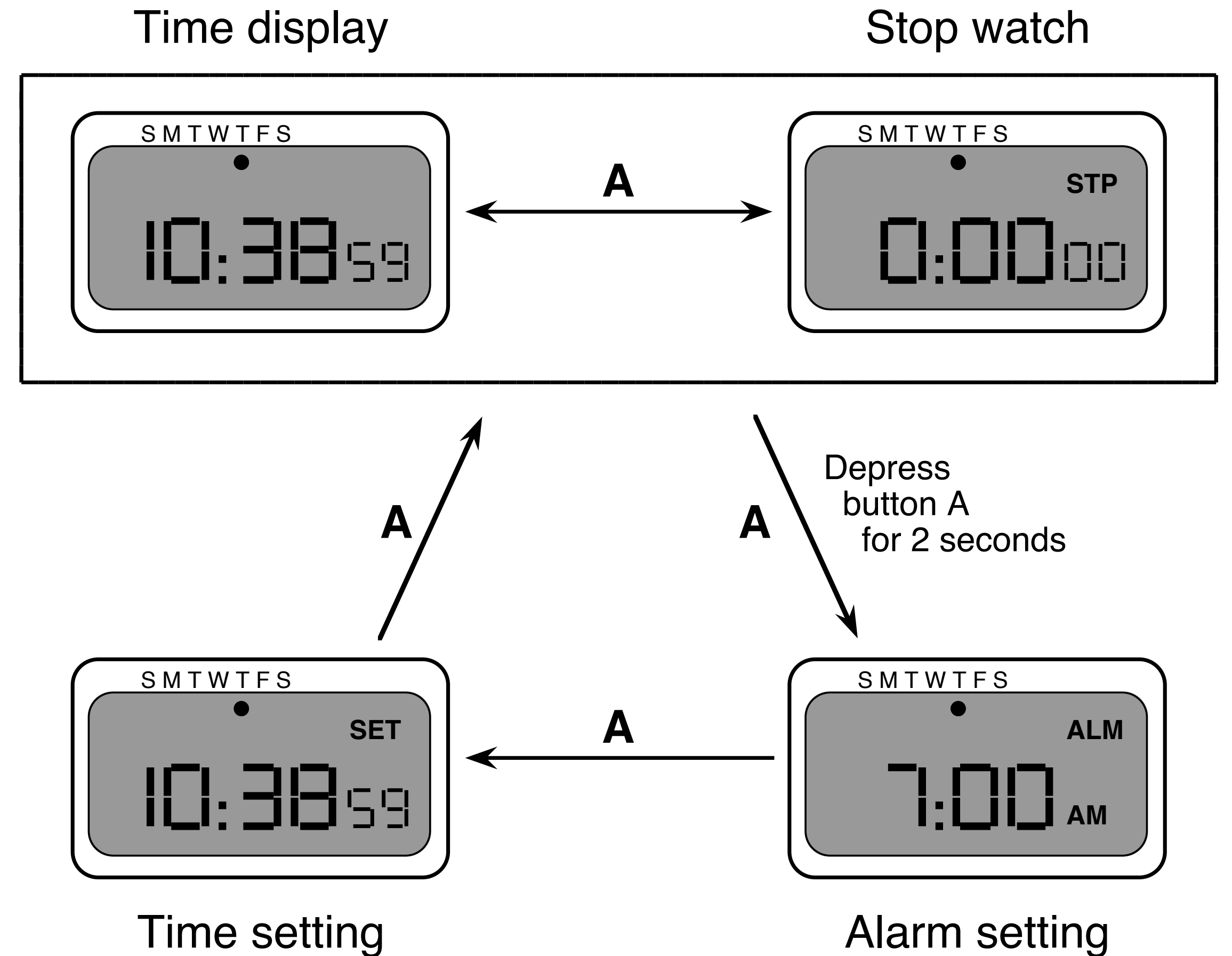

Digital Watch – User Instructions

and... that's just one button

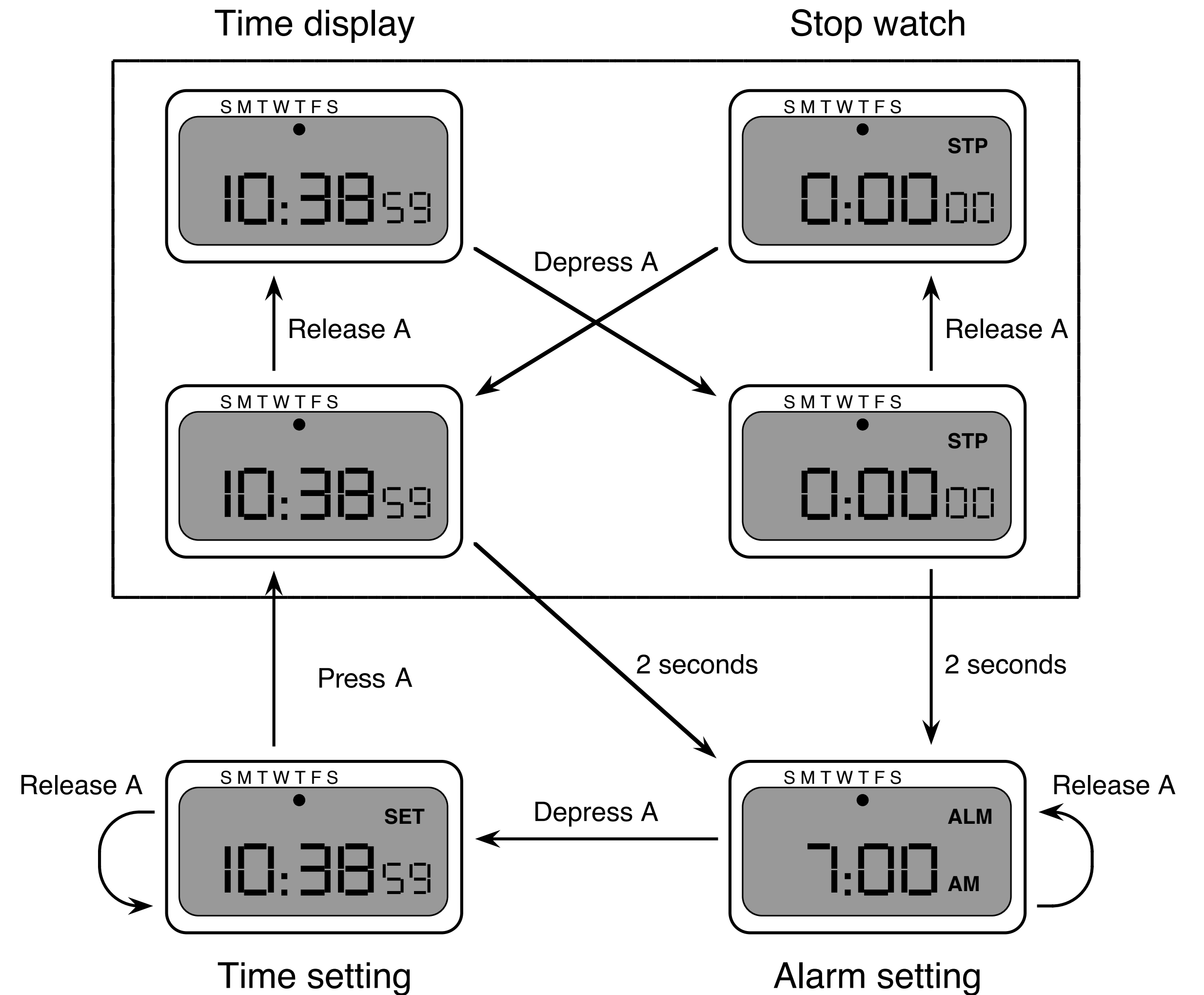

Semantics - Raw Code

- Event loop for word processor
- Dialogue description: very distributed
- Syntactic/semantic trade-off: terrible!

```
switch ( ev.type ) {
  case button_down:
    if ( in_text ( ev.pos ) ) {
      mode = selecting;
      mark_selection_start(ev.pos);
    }
    ...
  case button_up:
    if ( in_text ( ev.pos )
        && mode == selecting ) {
      mode = normal;
      mark_selection_end(ev.pos);
    }
    ...
  case mouse_move:
    if (mode == selecting ) {
      extend_selection(ev.pos);
    }
    ...
} /* end of switch */
```

Further Reading

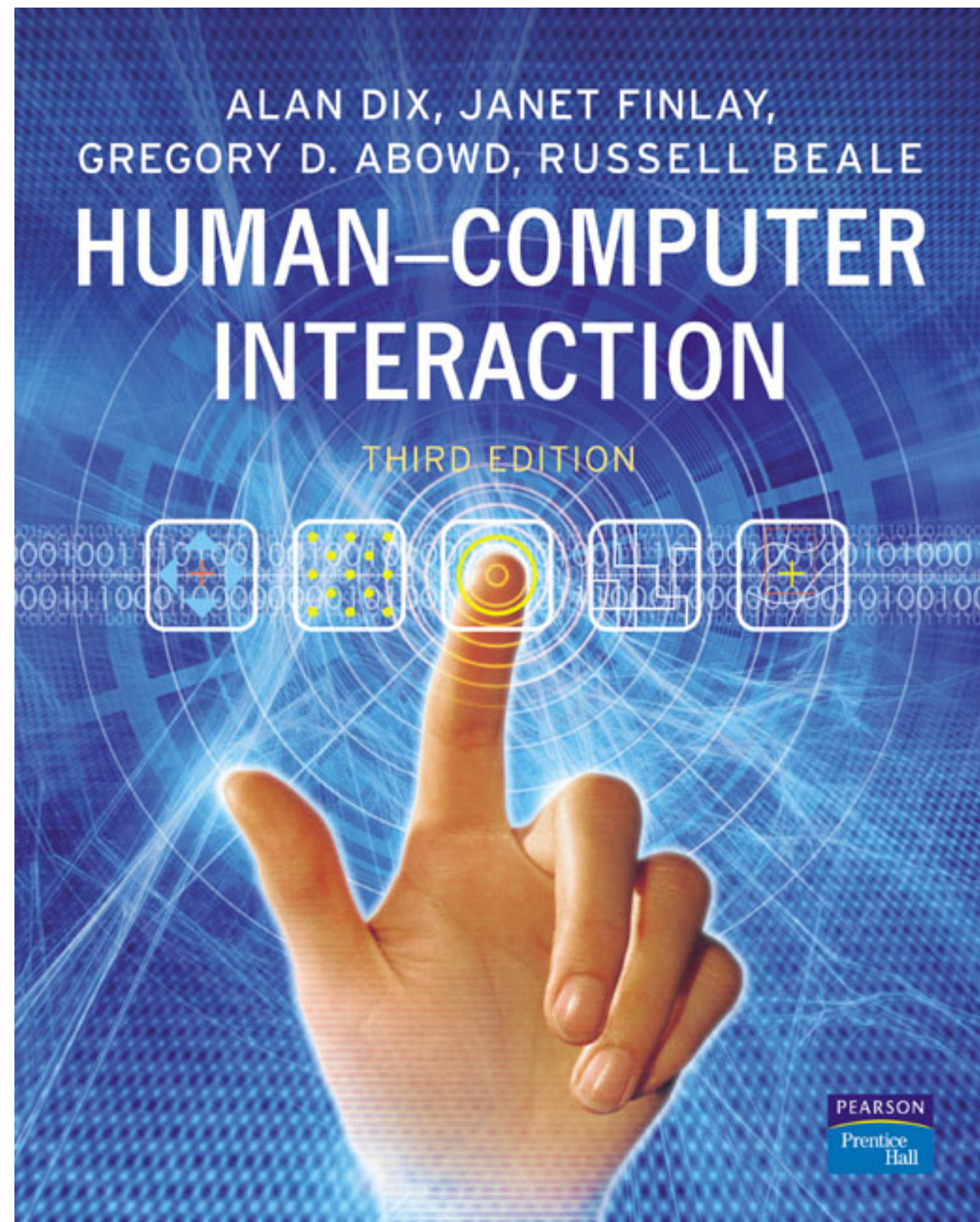

Alan Dix et al.:
Human-Computer Interaction,
3rd ed. (2003), Chapter 16

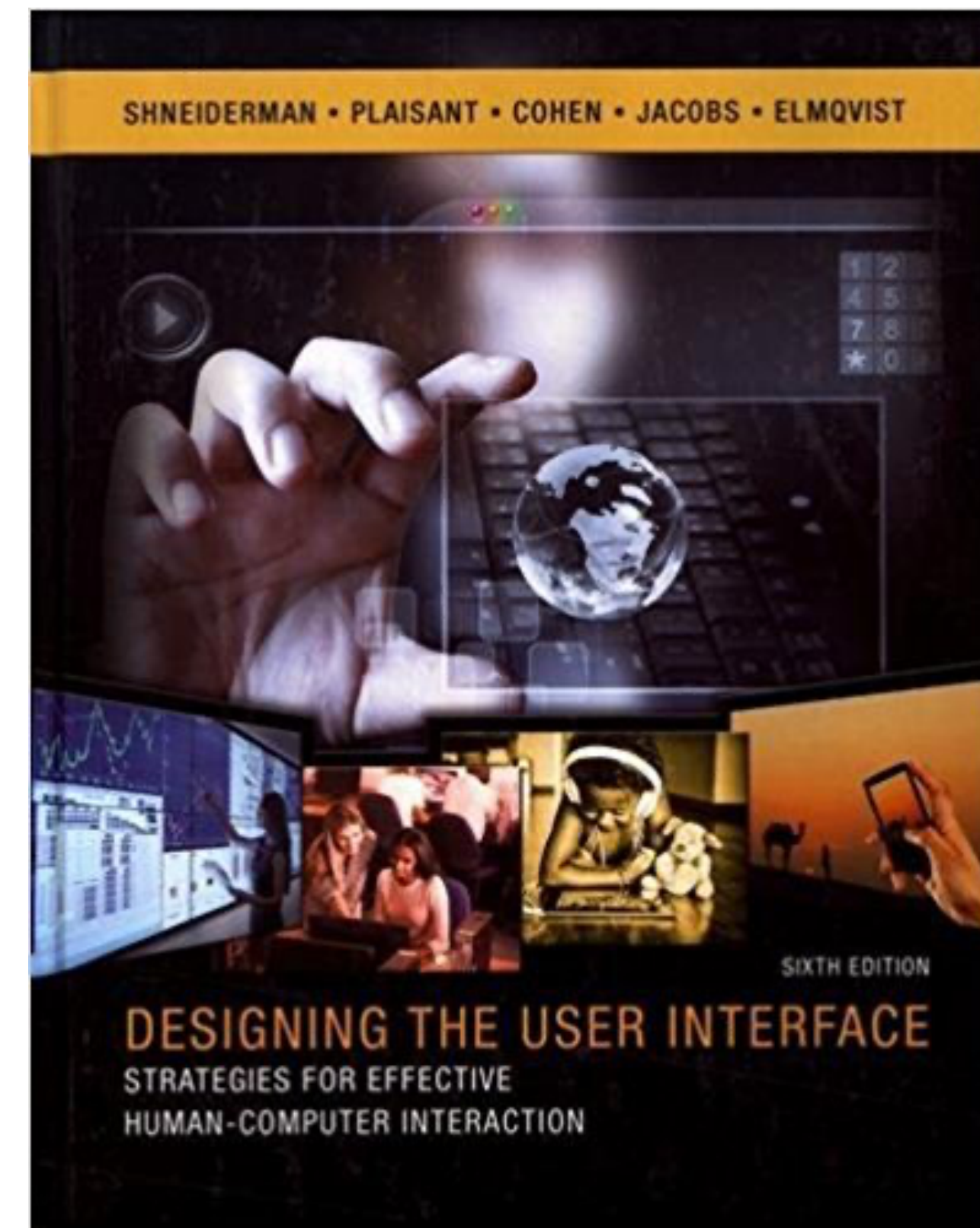

Ben Shneiderman:
Designing The User Interface,
6th ed. (2017), esp. Chapter 5

Roadmap

Human

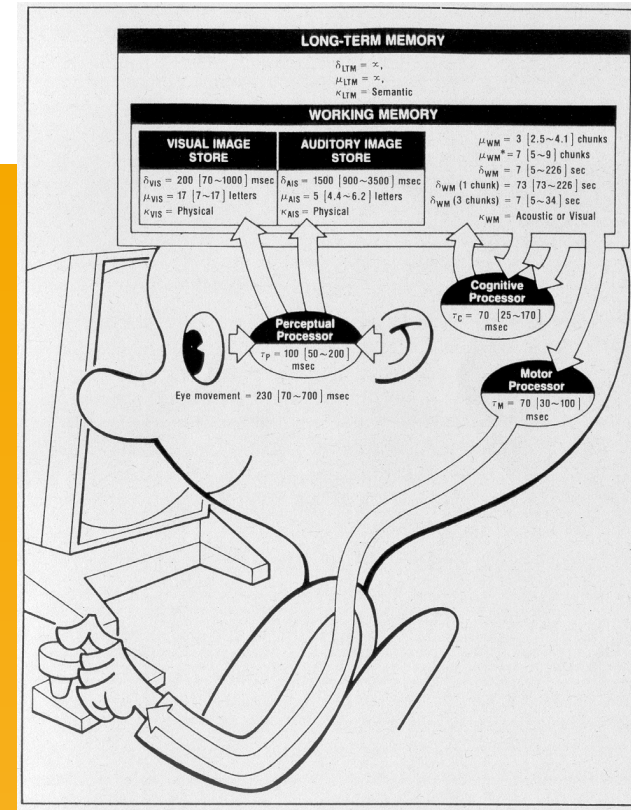

- Performance
- Models of interaction
 - Affordances
 - Mappings
 - Constraints
 - Types of knowledge
 - Errors
- Visual Design

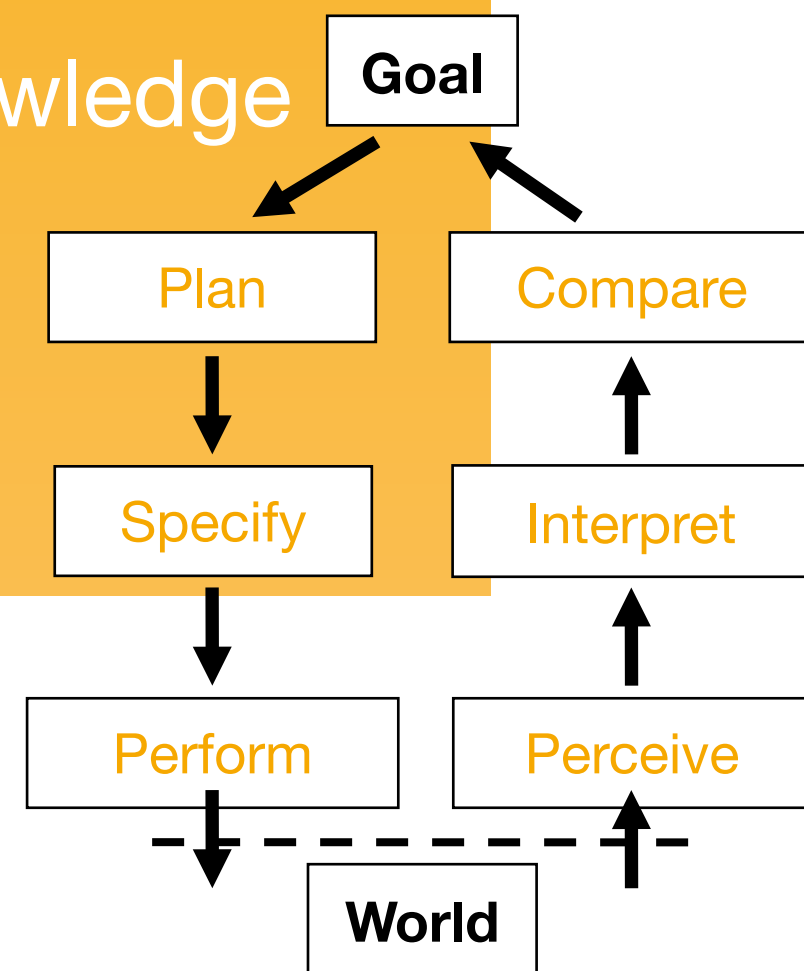

Case Studies

- History of HCI
- Visions
- Technology Phases



Development Process



- Iterative design
- User observation
- Ideation
- Prototyping
- User studies and evaluation
- Interaction design notation

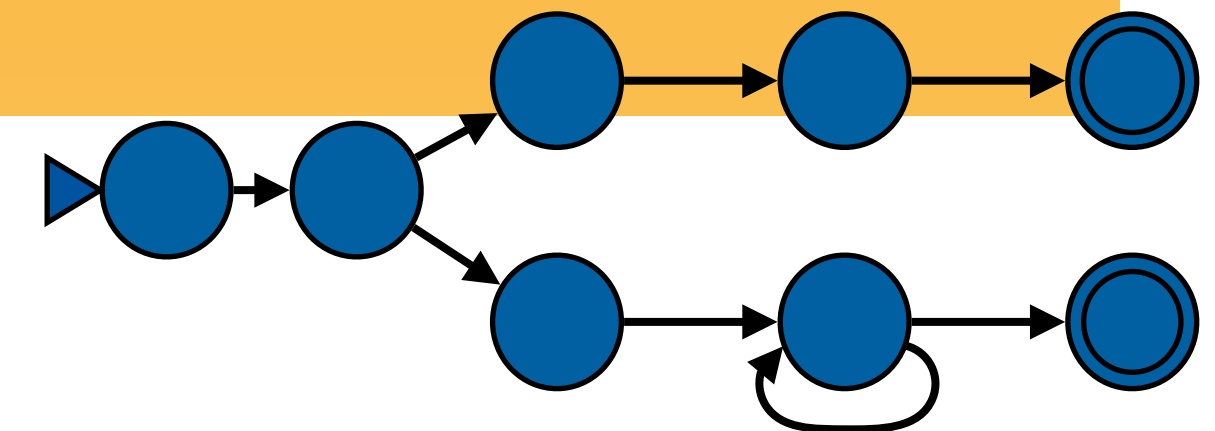

What's Next?

- **Designing Interactive Systems 2** (6 ECTS)

<https://hci.rwth-aachen.de/dis2>

- What makes a UI tick?

- Technical concepts, software paradigms and technologies behind HCI and user interface development

- **Current Topics in HCI** (6 ECTS)

<https://hci.rwth-aachen.de/cthci>

- Understand & practice ways to do research in HCI

- Learn about the latest research in HCI from recent conference and journal articles (and meet our Ph.D. students!)

Interested in a HiWi position or
B.Sc./M.Sc. thesis?
<https://hci.rwth-aachen.de/jobs>